

Hybrid Integrated DC DC converter HHD28 Series

1 Features of Hybrid Integrated DC DC converter HHD28 Series

- 16 to 40 VDC input, typical 28V
- 20W output power
- -55°C to +125°C operation
- Fully isolated
- More than 100M Ω (500V DC) isolation
- Inhibit function and indefinite short circuit protection
- Power Density: 28 W/in³
- Equivalent with Interpoint's MHD Series
- Hermetically sealed metal cases

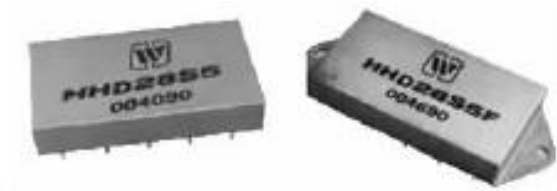

Size (max)

(non-flanged): 53.98x28.58x10.16mm³

(flanged): (73.91 x 28.58 x 10.16mm³)

Weight: 49grams for non-flanged

52grams for flanged

Figure 1 HHD28 Series DC/DC converters

2 Description of Hybrid Integrated DC DC converter HHD28 Series

The HHD28 Series of DC/DC converters offer up to 20 watts of output power with high reliability. The HHD28 series' small size, light weight, and hermetically sealed metal packages make them ideal for use in aviation aerospace and other high reliability applications.

The HHD28 series of converters use forward pulse width modulated topology design. The operating principle is that the sampling signal of output voltage, coupled by the opto-coupler, works together with the sampling signal of input loop current to regulate the pulse width of the controller. The double close loop control can create constant voltage output and short circuit protection. The magnetic feedback technology can effectively prevent the magnetic saturation of transformer and also products reliability can be improved.

Thick film hybrid techniques provide the HHD28 Series of converters with reliability levels and optimum miniaturization. The design and manufacturing process of HHD28 Series of converters are in compliance with General Standards of Hybrid Integrated Circuits and detailed standards of manufacturing. Connected to a HFD-CE03 filter, the HHD Series of converters can achieve better electromagnetic compatibility (EMC) performance.

Table 1 Product models

MODELS	
SINGLE	DUAL
HHD28S5(F)	HHD28D5(F)
HHD28S12(F)	HHD28D12(F)
HHD28S15(F)	HHD28D15(F)
HHD28S18(F)	

3 Electrical Performance of Hybrid Integrated DC DC converter

HHD28 Series

ABSOLUTE MAXIMUM RATINGS

- Input Voltage: 16~40
- Power dissipation: 6W
- Lead Soldering Temperature : 300°C (10 sec per lead)
- Storage Temperature Range (Case): -55°C ~ +125°C
- Inhibit voltage: $\leq 0.2V$
- Outside Sync. Signal:
 Frequency Range: 450~600kHz
 Duty Cycle:40%~60%
 TTL: $0.8 \leq V \leq 4.5V$

RECOMMENDED OPERATING CONDITIONS

- DC Input voltage range :16~ 40V
- Case Operating Temperature (Tc): -55°C to +125°C

HHD28S5(F) , HHD28S12(F)

Table 2 Electrical Characteristics: (T_{CASE} = -55°C to +125°C, V_{IN} = +28V ± 0.5V, Full Load_s, Unless Otherwise Specified)

Single output models		HHD28S5(F)		HHD28S12(F)		
Parameter	Conditions	Min	Max	Min	Max	
Output Voltage(V)	I _o =full load	Ambient temperature	4.95	5.05	11.88	12.12
		high and low temperature	4.85	5.15	11.64	12.36
Output Current(A)t	V _{IN} = 16 TO 40 VDC	-	3	-	1.67	
Output Power(W)	-	-	15	-	20	
Output Ripple Voltage (mV)	BW=10 kHz to 2 MHz I _o =full load	Ambient temperature	-	50	-	40
		high and low temperature	-	90	-	90
Line Regulation(mV)	V _{IN} = 16 TO 40 VDC, I _o =full load	-	50	-	50	
Load Regulation(mV)	I _o =No load to load	-	50	-	50	
Input Ripple Current (mA)	10 kHz - 2 MHz I _o =full load	-	50	-	50	
Efficiency (%)	I _o =full load	Ambient temperature	76	-	80	-
		high and low temperature	73	-	76	-
Isolation (MΩ)	Input to output or any pin to case (except case ground pin) at 500 VDC, T _A = 25° C	100	-	100	-	
Inhibit Function	T _A = 25° C, Inhibit voltage, output disabled	have		have		
Protection Function	T _A = 25° C	have		have		
Start-up Overshoot mV pk	V _{in} =0 to 28V, I _o =full load	-	50	-	120	
Start-up Delay(ms)	V _{in} =0 to 28V, I _o =full load	-	5	-	5	
Capacitive Load(μ F)	T _A = 25° C, No effect on DC performance	-	10000	-	3000	
Switching Frequency(kHz)	I _o =full load	400	600	400	600	
Step Load Response Transient(mV pK)	50% load -- full load -50% load	-300	300	-400	400	
Step Load Response Recovery (μ s)	50% load -- full load -50% load	-	200	-	200	
Step Line Response Transient (mV pK)	V _{in} =16~40V, I _o =full load	-300	300	-500	500	
	V _{in} =40~16V, I _o =full load					
Step Line Response Recovery t (μ s)	V _{in} =16~40V, I _o =full load	-	300	-	300	
	V _{in} =40~16V, I _o =full load					
Load Fault Short Circuit recovery (ms)	short circuit to full load	-	5	-	5	

Notes to Specifications:

- ① The step load transition time should be greater than or equal to 10 μ s.
- ② The step line transition time should be greater than or equal to 10 μ s.
- ③ Recovery time is measured from application of the transient to point at which V_{OUT} is within 1% of V_{OUT} at final value.

HHD28S15(F), HHD28S18(F)

Table 3 Electrical Characteristics: ($T_{CASE} = -55^{\circ}C$ to $+125^{\circ}C$, $V_{IN} = +28V \pm 0.5V$, Full Loads, Unless Otherwise Specified)

Single output models			HHD28S15(F)		HHD28S18(F)	
Parameter	Conditions		Min	Max	Min	Max
Output Voltage(V)	I_o =full load	Ambient temperature	14.85	15.15	17.82	18.18
		high and low temperature	14.55	15.45	17.46	18.54
Output Current(A)t	$V_{IN} = 16$ TO 40 VDC		-	1.33	-	1.11
Output Power(W)	-		-	20	-	20
Output Ripple Voltage (mV)	BW=10 kHz to 2 MHz I_o =full load	Ambient temperature	-	40	-	40
		high and low temperature	-	90	-	90
Line Regulation(mV)	$V_{IN} = 16$ TO 40 VDC, I_o =full load		-	50	-	50
Load Regulation(mV)	I_o =No load to load		-	50	-	50
Input Ripple Current (mA)	10 kHz - 2 MHz I_o =full load		-	50	-	50
Efficiency (%)	I_o =full load	Ambient temperature	81	-	81	-
		high and low temperature	76	-	76	-
Isolation (M Ω)	Input to output or any pin to case (except case ground pin) at 500 VDC, $T_A = 25^{\circ}C$		100	-	100	-
Inhibit Function	$T_A = 25^{\circ}C$, Inhibit voltage, output disabled		have		have	
Protection Function	$T_A = 25^{\circ}C$		have		have	
Start-up Overshoot mV pk	V_{in} =0 to 28V, I_o =full load		-	150	-	180
Start-up Delay(ms)	V_{in} =0 to 28V, I_o =full load		-	5	-	5
Capacitive Load(μ F)	$T_A = 25^{\circ}C$, No effect on DC performance		-	3000	-	2000
Switching Frequency(kHz)	I_o =full load		400	600	400	600
Step Load Response Transient(mV pK)	50% load -- full load -50% load		-500	500	-600	600
Step Load Response Recovery (μ s)	50% load -- full load -50% load		-	200	-	200
Step Line Response Transient (mV pK)	V_{in} =16~40V, I_o =full load		-600	600	-600	600
	V_{in} =40~16V, I_o =full load					
Step Line Response Recovery t (μ s)	V_{in} =16~40V, I_o =full load		-	300	-	300
	V_{in} =40~16V, I_o =full load					
Load Fault Short Circuit recovery (ms)	short circuit to full load		-	5	-	5

Notes to Specifications:

- ③ The step load transition time should be greater than or equal to 10 μ s.
- ④ The step line transition time should be greater than or equal to 10 μ s.
- ③ Recovery time is measured from application of the transient to point at which V_{OUT} is within 1% of V_{OUT} at final value.

HHD28D5, HHD28D12(F), HHD28D15(F)

Table 4 Electrical Characteristics: ($T_{CASE} = -55^{\circ}C$ to $+125^{\circ}C$, $V_{IN} = 28V \pm 0.5V$, Full Load_s, Unless Otherwise Specified)

Dual output models			HHD28D5		HHD28D12(F)		HHD28D15(F)		
Parameter	Conditions		Min	Max	Min	Max	Min	Max	
Output Voltage (V)	$I_{O1} = I_{O2} = \text{full load}$	Ambient temperature	4.950	5.050	11.88	12.12	14.85	15.15	
		high and low temperature	4.850	5.150	11.64	12.36	14.55	15.45	
		Ambient temperature	-5.075	-4.925	-12.18	-11.82	-15.23	-14.77	
		high and low temperature	-5.175	-4.825	-12.42	-11.58	-15.53	-14.47	
Output Current (A) _t	$V_{IN} = 16 \text{ TO } 40 \text{ VDC}$		-	1.5	-	0.625	-	0.5	
Output Power(W)	-		-	15	-	15	-	15	
Output Ripple Voltage (mV)	BW=10 kHz to 2 MHz(BW \leq 20MHz) $I_o = \text{fullload}$	Ambient temperature	-	50	-	80	-	80	
		high and low temperature	-	80	-	120	-	120	
		Ambient temperature	-	50	-	80	-	80	
		high and low temperature	-	80	-	120	-	120	
Line Regulation (mV)	$V_{IN} = 16 \text{ TO } 40 \text{ VDC}$, $I_o = \text{full load}$		+V _{out}	-	50	-	50	-	50
			-V _{out}	-	100	-	150	-	180
Load Regulation (mV)	$I_o = \text{No load to full load}$		+V _{out}	-	50	-	50	-	50
			-V _{out}	-	100	-	150	-	150
Input Ripple Current (mA)	BW=10 kHz to 10 MHz $I_{O1} = I_{O2} = \text{full load}$		-	50	-	50	-	50	
Efficiency (%)	$I_o = \text{fullload}$	Ambient temperature	76	-	79	-	80	-	
		high and low temperature	70	-	76	-	76	-	
Isolation (M Ω)	Input to output or any pin to case (except case ground pin) at 500 VDC, $T_A = 25^{\circ}C$			100	-	100	-	100	
Inhibit Function	$T_A = 25^{\circ}C$, Inhibit voltage, output disabled		have		have		have		
Protection Function	$T_A = 25^{\circ}C$		have		have		have		
Start-up Overshoot mV pk	$V_{in} = 0 \text{ to } 28V$, $I_o = \text{full load}$		-50	50	-120	120	-150	150	
Start-up Delay (ms)	$V_{in} = 0 \text{ to } 28V$, $I_o = \text{full load}$		-	5	-	5	-	5	

(to be continued)

Capacitive Load (μF)	$T_A = 25^\circ C$, No effect on DC performance	-	500	-	500	-	500
Switching Frequency(kHz)	I_o =full load	400	600	400	600	400	600
Step Load Response Transient(mV pK)	50% load to full load or full load to 50% load, Each V_{out} has balanced load	-300	300	-300	300	-400	400
Step Load Response Recovery t (μs)	50% load to full load or full load to 50% load, Each V_{out} has balanced load	-	200	-	200	-	200
Step Line Response Transient (mV pK)	V_{in} =16~40V, $I_{o1}= I_{o2}$ =full load	-400	400	-400	400	-500	500
Step Line Response Recovery t (μs)	V_{in} =16~40V, $I_{o1}= I_{o2}$ =full load	-	300	-	300	-	300
Load Fault Short Circuit recovery (ms)	$I_{o1}= I_{o2}$ short circuit to full load	-	5	-	5	-	5

Notes to Specifications:

- ① The step load transition time should be greater than or equal to $10 \mu s$.
- ② The step line transition time should be greater than or equal to $10 \mu s$.
- ③ Recovery time is measured from application of the transient to point at which V_{OUT} is within 1% of V_{OUT} at final value.

4 Typical Performance Curves of Hybrid Integrated DC DC converter

HHD28 Series

(1) Single output model HHD28S5

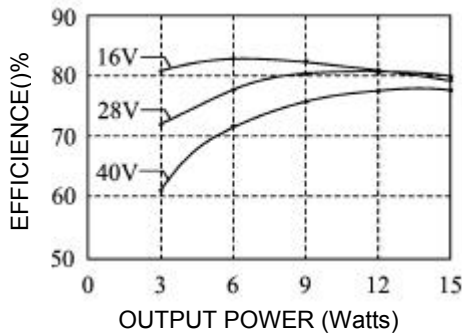

Figure 2 Efficiency (OUTPUT POWER)

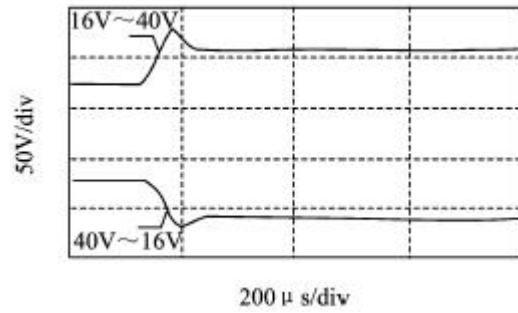

Figure 3 STEP LINE RESPONSE

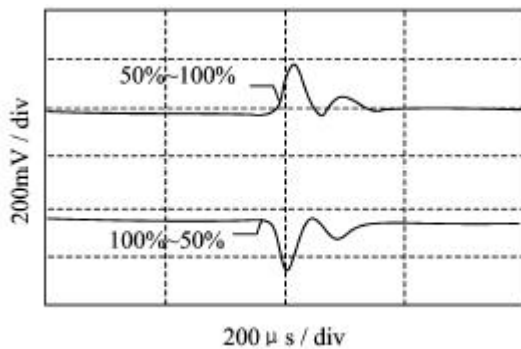

Figure 4 STEP LOAD RESPONSE

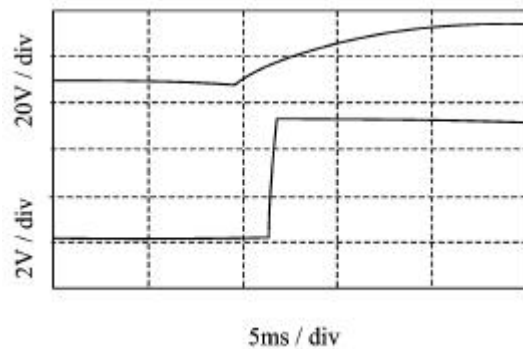

Figure 5 Start-up overshoot/ delay

(2) Dual output model HHD28D15

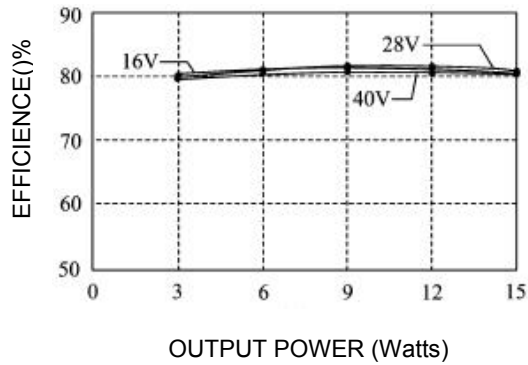

Figure 6 Efficiency (OUTPUT POWER)

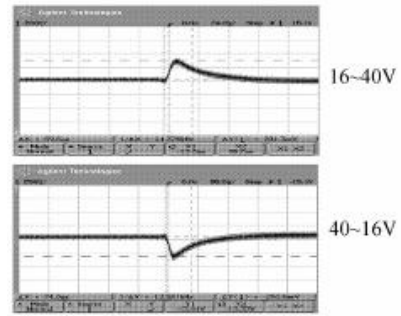

Figure 7 STEP LINE RESPONSE

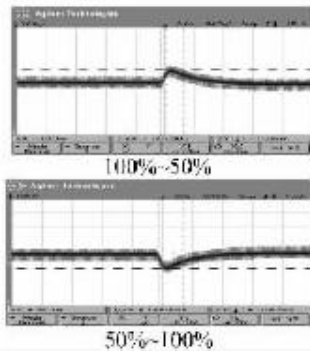

Figure 8 STEP LOAD RESPONSE

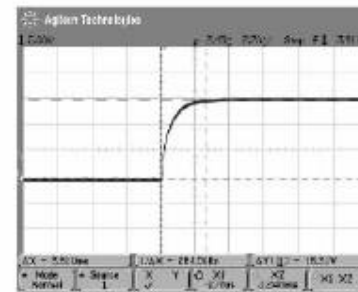

Figure 9 Start-up overshoot/ delay

5 Typical MTBF Curves Hybrid Integrated DC DC converter HHD28 Series

Series

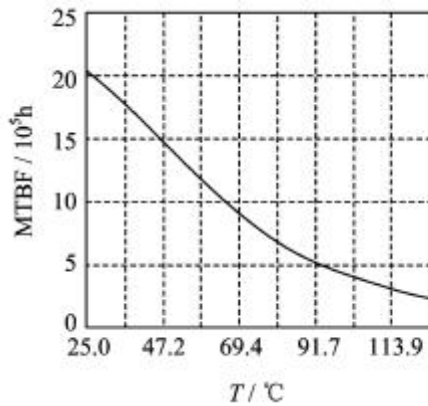

Figure10 Model HHD28S5

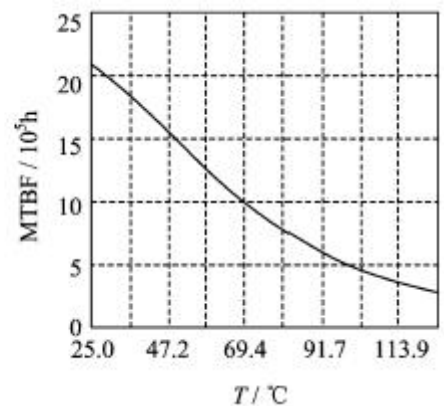

Figure 11 Model HHD28D

6 Typical Connection Diagram of Hybrid Integrated DC DC converter HHD28 Series

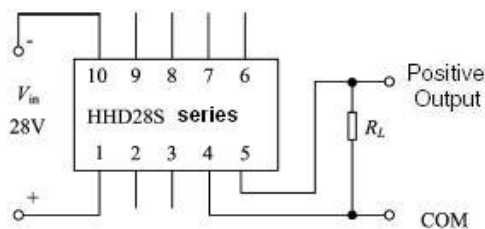

Figure12 Application Connection Diagram for Single Output Models

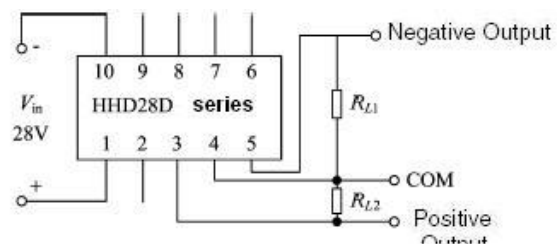

Figure13 Application Connection Diagram for Dual Output Models

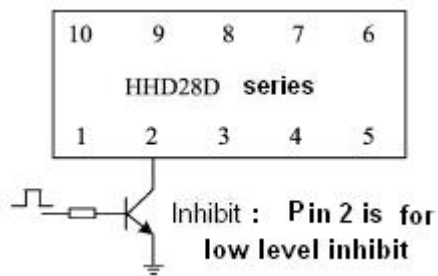

Figure14 Inhibit Drive connection Diagram

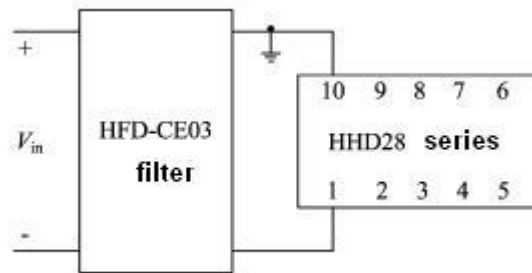

Figure15 Dual Output Converter with EMI Filter connection Diagram

7 Package Specifications of Hybrid Integrated DC DC converter HHD28 Series

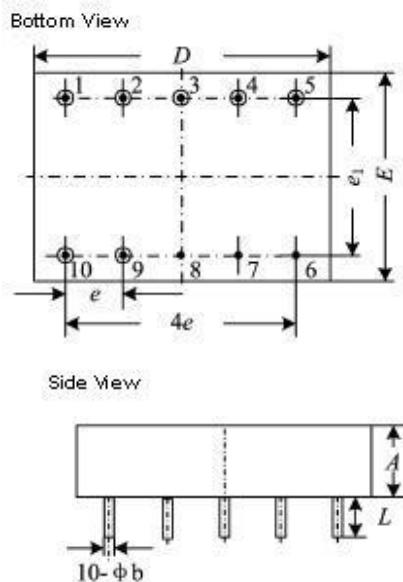

Figure16 Non-flanged outline

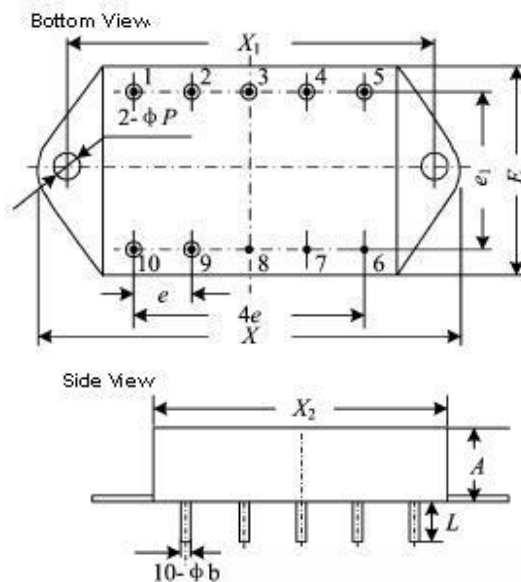

Figure17 Flanged outline

Table 5 Package Dimension

Dimension Symbols	Units/mm		
	Min	Typ	Max
A	—	—	8.38
φ b	A	—	0.89
	B	—	1.1
D	36.70	—	36.96
e	—	5.08	—
e ₁	—	20.32	—
e ₂	—	7.62	—
e ₃	—	12.70	—
e ₄	—	10.16	—
E	28.32	—	28.58
E ₁	—	—	28.70
L	6.09	—	6.60
φ P	3.17	—	3.43
X	—	—	50.80
X ₁	43.82	—	44.07
X ₂	—	—	36.83

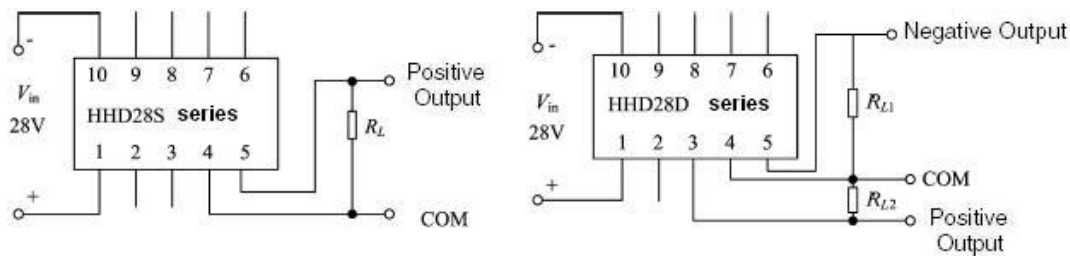

Table 6 Case Materials

Case Model	Header	Header Plating	Cover	Cover Plating	Pin	Pin Plating	Sealing Style	Notes
UPP5328-10d	Cold Rolled Steel (10#)	Nickel	Iron/Nickel Alloy (4J42)	Nickel	Copper Compound	Nickel/Gold	Compression Seal	Nickel plating is for pin6/7/8

Notes:

Solder pins individually with heat application not exceeding 300° C for 10 seconds per pin.

8 Pin Designation of Hybrid Integrated DC DC converter HHD28 Series

Table 7 Pin Designation

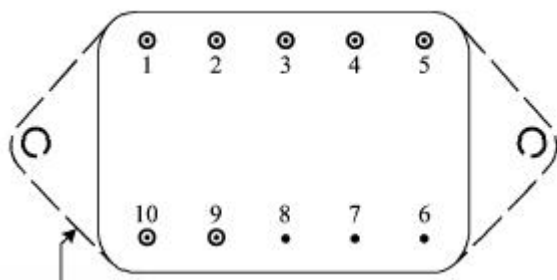

Figure20 Pin Out Bottom View of flanged outline

Pin	Single Output	Dual Output
1	Positive Input	Positive Output
2	Inhibit	Inhibit
3	No connection	Output Common
4	Output Common	Negative Output
5	Positive Output	Sync
6	Case Ground	Case Ground
7	Case Ground	Case Ground
8	Case Ground	Case Ground
9	Sync	Sync
10	Input Common	Input Common

9 Ordering Information of Hybrid Integrated DC DC converter HHD28 Series

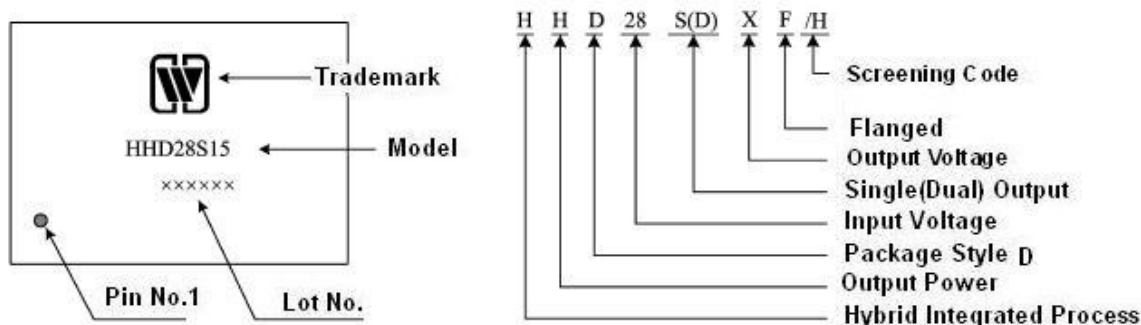

Figure 21 Part Numbering Key

Application Notes:

- The correct power supply is to be ensured that may not cause permanent damage to the device.
- When the electrical performance is tested, the testing position should be pin of the device.
- When the device is mounted, the bottom of the device should be closely attached to the circuit board. So as to avoid the damage of the pins, the shockproof should be increased when it is required.
- The pin should not be bending to avoid the glass insulator broken and cause the leakage.
- For 15W DC/DC converter:
 - When the case temperature is at 105℃, it is suggested that thickness of the thermal sinking plate(copper material) is 3mm, the dimension is greater than 85mm×50mm.
 - When the case temperature is at 125℃, it is suggested that thickness of the thermal sinking plate(copper material) is 3mm, the dimension is greater than 70mm×50mm.
- For 20W DC/DC converter:
 - When the case temperature is at 105℃, it is suggested that thickness of the thermal sinking plate(copper material) is 3mm, the dimension is greater than 80mm×70mm.
 - When the case temperature is at 125℃, it is suggested that thickness of the thermal sinking plate(copper material) is 3mm, the dimension is greater than 80mm×65mm

To request a quotation or place orders please contact our sales representative or the ECRIM Sales Department at:

Sales Phone: (086) 0551-3667943

Sales Fax: (086) 0551-3638101

E-mail: sales@ecrim.cn