

## Mil Grade DC DC converters- HSA28 Series

### 1 FEATURES of Mil Grade DC DC converters- HSA28 Series

- 16 to 40 VDC input, typical 28V
- Model HSA15S5 10 to 20V DC output, typical 15V
- 5W output power
- -55°C to +125°C operation
- Fully isolated
- More than 100MΩ(500V DC) isolation
- Inhibit function and indefinite short circuit protection
- 500kHz operating frequency
- Equivalent with Interpoint's MSA Series
- Hermetically sealed metal cases



Size : (non-flanged) 27.31x27.31x 6.86 mm<sup>3</sup>  
(flanged): 39.0 x 27.31 x 6.86 mm<sup>3</sup>

Weight: (non-flanged): 18grams  
(flanged): 20grams

Figure 1 HSA28 Series DC/DC converters

Table 1 Product models

MODELS	
SINGLE	DUAL
HSA28S5(F)	HSA28D5(F)
HSA28S12(F)	HSA28D12(F)
HSA28S15(F)	HSA28D15(F)
HSA28S5R2(F)	
HSA28S60(F)	
HSA15S5(F)	
HSA28S28R5(F)	
HSA28S3R3(F)	
HSA28S2R5	
HSA28S2R5-A(F)	

### 2 DESCRIPTION of Mil Grade DC DC converters- HSA28 Series

The HSA28 Series of DC/DC converters offer up to 5 watts of output power with high reliability. The HSA28 series' small size, light weight, and hermetically sealed metal packages make them ideal for use in aviation, aerospace and other high reliability applications.

The HSA 28 series of converters use single ended forward or flyback pulse width modulated topology design. The operating principle is that the sampling signal of output voltage, coupled by the opto-coupler, works together with the sampling signal of input loop current to regulate the pulse width of the controller. The double close loop control can create constant voltage output and short circuit protection.

Thick film hybrid techniques provide the HSA28 Series of converters with reliability levels and optimum miniaturization. The design and manufacturing process of HSA28 Series of converters are in compliance with General Standards of Hybrid Integrated Circuits and detailed standards of manufacturing. Connected to a HFD-CE03 filter, the HSA28 Series of converters can achieve better electromagnetic compatibility (EMC) performance.

### 3 ELECTRICAL PERFORMANCE of Mil Grade DC DC converters- HSA28 Series

#### ABSOLUTE MAXIMUM RATINGS

- Input Voltage: 40V ( 20V for Model HSA15S5)
- Power dissipation: 2.6W
- Output power: 5.7W
- Lead Soldering Temperature : 300°C (10 sec per lead)
- Storage Temperature Range (Case): -55°C ~ +125°C
- Inhibit voltage:  $\leq 0.2V$

#### RECOMMENDED OPERATING CONDITIONS

- DC Input voltage range :16~ 40V  
(10~20V for Model HSA15S5 )
- Case Operating Temperature (Tc): -55°C to +125°C

#### HSA28S5(F), HSA28S12(F), HSA28S15(F)

Table 2 Electrical Characteristics(TCASE = -55°C to +125°C, VIN = 28V ± 0.5V, Full Load5, Unless Otherwise Specified)

Single output models			HSA28S5(F)		HSA28S12(F)		HSA28S15(F)	
Parameter	Conditions		Min	Max	Min	Max	Min	Max
Output Voltage (V)	Io=full load	Ambient temperature	4.95	5.05	11.88	12.12	14.85	15.15
		high and low temperature	4.80	5.20	11.52	12.48	14.40	15.60
Output Current (A)	Vin = 16 TO 40 VDC		-	1	-	0.417	-	0.333
Output Power (W)	-		-	5	-	5	-	5
Output Ripple Voltage(mV)	BW=10kHz to 2 MHz Io=full load	Ambient temperature	-	350	-	200	-	170
		high and low temperature	-	525	-	300	-	250
Line Regulation (mV)	VIN= 16 TO 40 VDC,Io=full load		--	50	-	50	-	50
Load Regulation (mV)	Io=No load to full load		-	50	-	50	-	50
Input Ripple Current (mA)	BW=10kHz-2 MHz Io=full load	Ambient temperature	-	100	-	100	-	100
		high and low temperature	-	150	-	150	-	150
Efficiency (%)	Io=full load	Ambient temperature	66	-	70	-	71	-
		high and low temperature	64	-	68	-	69	-
Isolation (MΩ)	Input to output or any pin to case (except case ground pin) at 500 VDC, TA = 25° C		100	-	100	-	100	-
Inhibit Function	TA = 25° C, Inhibit voltage, output disabled		have		have		have	
Protection Function	TA = 25° C		have		have		have	
Start-up Overshoot (mV pk)	Vin=0 to 28V, Io=full load		-	500	-	500	-	500
Start-up Delay (ms)	Vin=0 to 28V, Io=full load		-	75	-	30	-	30
Capacitive Load(μF)	TA = 25° C, No effect on DC performance		-	300	-	500	-	500
Switching Frequency (kHz)	Io=full load		400	600	400	600	400	600
Step Load Response Transient(mV pK)	50% load -- full load -50% load	Ambient temperature high and low temperature	-250	250	-375	375	-500	500
			-750	750	-1100	1100	-1500	1500
Step Load Response Recovery (μs)	50% load -- full load -50% load	Ambient temperature high and low temperature	-	250	-	500	-	500
			-	1500	-	3000	-	3500
Step Line Response Transient (mV pK)	Vin=16~40V, Io=full load Vin=40~16V, Io=full load		-500	500	-1000	800	-500	500
Step Line Response Recovery (μs)	Vin=16~40V, Io=full load Vin=40~16V, Io=full load	-	500	-	1300	-	1300	
		-	900	-		-		
Load Fault Short Circuit recovery (ms)	Io from short circuit to full load		-	75	-	30	-	30

Notes to Specifications:

- ① The step load transition time should be greater than or equal to 10 $\mu$ s.
- ② The step line transition time should be greater than or equal to 10 $\mu$ s.
- ③ Recovery time is measured from application of the transient to point at which  $V_{OUT}$  is within 1% of  $V_{OUT}$  at final value.

**HSA28S5R2(F), HSA28S60(F), HSA15S5(F)**

Table 3 Electrical Characteristics: ( $T_{CASE} = -55^{\circ}C$  to  $+125^{\circ}C$ ,  $V_{IN} = 28V \pm 0.5V$ , Full Load<sup>5</sup>, Unless Otherwise Specified)

Single output models			HSA28S5R2(F)		HSA28S60(F)		HSA15S5(F)	
Parameter	Conditions		Min	Max	Min	Max	Min	Max
Output Voltage (V)	$I_o$ =full load	Ambient temperature	5.15	5.25	59.1	60.9	5.0	5.1
		high and low temperature	4.99	5.41	56.0	64.0	4.9	5.2
Output Current(A)	$V_{IN} = 16$ TO $40$ VDC( $V_{IN} = 10$ TO $20$ VDC)		-	0.962	-	0.020	-	0.8
Output Power(W)	-		-	5.2	-	5.2	-	5
Output Ripple Voltage (mV)	BW=10 kHz to 2 MHz ( $BW \leq 20$ MHz) $I_o$ =full load	Ambient temperature	-	350	-	300	-	50
		high and low temperature	-	525				
Voltage Regulation (mV)	$V_{IN} = 16$ TO $40$ VDC,( $V_{IN} = 10$ TO $20$ VDC) $I_o$ =full load		-	50	-	300	-	50
Load Regulation(mV)	$I_o$ =No load to load		-	50	-	300	-	50
Input Ripple Current(mA)	BW=10kHz to 2MHz, $I_o$ =full load	Ambient temperature	-	100	-	90	-	-
		high and low temperature	-	150	-	-	-	-
Efficiency (%)	$I_o$ =full load	Ambient temperature	66	-	70	-	72	-
		high and low temperature	64	-	65	-	-	-
Isolation(M $\Omega$ )	Input to output or any pin to case (except case ground pin) at 500 VDC, $T_A = 25^{\circ}C$		100	-	100	-	100	-
Inhibit Function	$T_A = 25^{\circ}C$ , Inhibit voltage, output disabled		have		have		have	
Protection Function	$T_A = 25^{\circ}C$		have		have		have	
Start-up Overshoot (mV pk)	$V_{in}$ =16 to 40V, $I_o$ =full load		-	500	-	-	-	-
Start-up Delay (ms)	$V_{in}$ =16 to 40V, $I_o$ =full load		-	75	-	-	-	25
Capacitive Load ( $\mu$ F)	$T_A = 25^{\circ}C$ , No effect on DC performance		-	300	-	-	-	-
Switching Frequency(kHz)	$I_o$ =full load		400	600	400	600	-	-
Step Load Response Transient(mV pK)	50% load -- full load -50% load	Ambient temperature	-250	250	-	-	-	-
		high and low temperature	-750	750				
Step Load Response Recovery ( $\mu$ s)	50% load -- full load -50% load	Ambient temperature	-	250	-	-	-	-
		high and low temperature	-	1500				
Step Line Response Transient (mV pK)	$V_{in}$ =16~40V, $I_o$ =full load $V_{in}$ =40~16V, $I_o$ =full load		-500	500	-	-	-	-
Step Line Response Recovery ( $\mu$ s)	$V_{in}$ =16~40V, $I_o$ =full load $V_{in}$ =40~16V, $I_o$ =full load		-	500	-	-	-	-
			-	900				
Load Fault Short Circuit recovery ms)	$I_o$ from short circuit to full load		-	75	-	-	-	-

Notes to Specifications:

- ① The step load transition time should be greater than or equal to 10 $\mu$ s.
- ② The step line transition time should be greater than or equal to 10 $\mu$ s.
- ③ Recovery time is measured from application of the transient to point at which  $V_{OUT}$  is within 1% of  $V_{OUT}$  at final value.

**HSA28S28R5(F), HSA28S3R3(F)**

Table 4 Electrical Characteristics: ( $T_{CASE} = -55^{\circ}C$  to  $+125^{\circ}C$ ,  $V_{IN} = 28V \pm 0.5 V$ , Full Loads, Unless Otherwise Specified)

Single output models		HSA28S28R5(F)		HSA28S3R3(F)		
Parameter	Conditions	Min	Max	Min	Max	
Output Voltage (V)	$I_o$ =full load	Ambient temperature	28.2	29	3.20	3.40
		high and low temperature	27.7	29.3	3.15	3.45
Output Current (A)	$V_{IN} = 16$ TO 40 VDC	-	0.2	0	1.2	
Output Power (W)	-	-	5.7	-	4.5	
Output Ripple Voltage (mV)	BW=10 kHz to 2 MHz $I_o$ =full load	-	60	-	50	
Line Regulation (mV)	$V_{IN} = 16$ TO 40 VDC, ( $V_{IN} = 10$ TO 20 VDC) $I_o$ =full load	Ambient temperature	-	28	-	50
		high and low temperature	-	-	-	100
Load Regulation(mV)	$I_o$ =No load to load	Ambient temperature	-	140	-	50
		high and low temperature	-	-	-	100
Efficiency (%)	$I_o$ =full load	75	-	70	-	
Isolation (M $\Omega$ )	Input to output or any pin to case (except case ground pin) at 500 VDC, $T_A = 25^{\circ} C$	100	-	100	-	
Inhibit Function	$T_A = 25^{\circ} C$ , Inhibit voltage, output disabled	have		have		
Protection Function	$T_A = 25^{\circ} C$					
Start-up Overshoot (mV pk)	$V_{in}$ =0 to 28V, $I_o$ =full load	-	-	-	-	
Start-up Delay(ms)	$V_{in}$ =0to 28V, $I_o$ =full load	-	5	-	5	
Capacitive Load( $\mu$ F)	$T_A = 25^{\circ} C$ , No effect on DC performance	-	-	-	-	
Switching Frequency (kHz)	$I_o$ =full load	400	600	-	-	

### HSA28S2R5 , HSA28S2R5-A(F)

Table 5 Electrical Characteristics: ( $T_{CASE} = -55^{\circ}C$  to  $+125^{\circ}C$ ,  $V_{IN} = 28V \pm 0.5V$ , Full Loads, Unless Otherwise Specified)

Single output models		HSA28S2R5		HSA28S2R5-A(F)		
Parameter	Conditions	Min	Max	Min	Max	
Output Voltage (V)	$I_o = \text{full load}$	Ambient temperature	2.40	2.60	2.40	2.60
		high and low temperature	2.35	2.65	2.35	2.65
Output Current (A)	$V_{IN} = 16 \text{ TO } 40 \text{ VDC}$	0	1	0	2	
Output Power (W)	-	-	3	-	5.5	
Output Ripple Voltage (mV)	BW=10 kHz to 2 MHz $I_o = \text{full load}$	-	80	-	35	
Line Regulation (mV)	$V_{IN} = 16 \text{ TO } 40 \text{ VDC}, (V_{IN} = 10 \text{ TO } 20 \text{ VDC})$ $I_o = \text{full load}$	Ambient temperature	-	50	-	10
		high and low temperature	-	100	-	20
Load Regulation (mV)	$I_o = \text{No load to load}$	Ambient temperature	-	50	-	50
		high and low temperature	-	100	-	70
Efficiency (%)	$I_o = \text{full load}$	60	-	68	-	
Isolation (M $\Omega$ )	Input to output or any pin to case (except case ground pin) at 500 VDC, $T_A = 25^{\circ}C$	100	-	100	-	
Inhibit Function	$T_A = 25^{\circ}C$ , Inhibit voltage, output disabled	have		have		
Protection Function	$T_A = 25^{\circ}C$	have		have		
Start-up Overshoot (mV pk)	$V_{in} = 0 \text{ to } 28V, I_o = \text{full load}$	-	-	-	-	
Start-up Delay (ms)	$V_{in} = 0 \text{ to } 28V, I_o = \text{full load}$	-	5	-	5	
Capacitive Load ( $\mu F$ )	$T_A = 25^{\circ}C$ , No effect on DC performance	-	-	-	-	
Switching Frequency (kHz)	$I_o = \text{full load}$	-	-	-	-	

**HSA28D5(F), HSA28D12(F), HSA28D15(F)**

Table 6 Electrical Characteristics: ( $T_{CASE} = -55^{\circ}C$  to  $+125^{\circ}C$ ,  $V_{IN} = +28V \pm 0.5V$ , Full Loads, Unless Otherwise Specified)

Dual output models			HSA28D5(F)		HSA28D12(F)		HSA28D15(F)	
Parameter	Conditions		Min	Max	Min	Max	Min	Max
Output Voltage (V)	$I_{O1} = I_{O2} =$ full load	Ambient temperature	4.95	5.05	11.88	12.12	14.85	15.15
		high and low temperature	4.80	5.20	11.52	12.48	14.40	15.60
		Ambient temperature	-5.10	-4.90	-12.24	-11.76	-15.30	-14.70
		high and low temperature	-5.25	-4.75	-12.96	-11.04	-16.20	-13.80
Output Current (A)	$V_{IN} = 16$ TO $40$ VDC		-	0.5	-	0.208	-	0.167
Output Power (W)	-		-	5.23	-	5.3	-	5.3
Output Ripple Voltage (mV)	BW=10 kHz to 2 MHz(BW $\leq$ 20M Hz) $I_{O1} = I_{O2} =$ full load	Ambient temperature	-	150	-	140	-	150
		high and low temperature	-	300	-	250	-	250
		Ambient temperature	-	150	-	140	-	150
		high and low temperature	-	300	-	250	-	250
Line Regulation (mV)	$V_{IN} = 16$ TO $40$ VDC, $I_{O1} = I_{O2} =$ full load	+V <sub>out</sub>	-	25	-	50	-	50
		-V <sub>out</sub>	-	75	-	180	-	180
Load Regulation (mV)	$I_{O1} = I_{O2} =$ No load to full load	+V <sub>out</sub>	-	50	-	50	-	50
		-V <sub>out</sub>	-	200	-	200	-	200
Efficiency (%)	$I_{O1} = I_{O2} =$ full load	Ambient temperature	68	-	69	-	70	-
		high and low temperature	65	-	67	-	68	-
Isolation (M $\Omega$ )	Input to output or any pin to case (except case ground pin) at 500 VDC, $T_A = 25^{\circ}C$			100	-	100	-	100
Inhibit Function	$T_A = 25^{\circ}C$ , Inhibit voltage, output disabled		have		have		have	
Protection Function	$T_A = 25^{\circ}C$		have		have		have	
Start-up Overshoot (mV pk)	$V_{in} = 0$ to 28V, $I_{O1} = I_{O2} =$ full load	Ambient temperature	-	500	-	500	-	500
		high and low temperature	-	750			-	750
		Ambient temperature	-	500			-	500
		high and low temperature	-	750			-	750
Start-up Delay (ms)	$V_{in} = 0$ to 28V, $I_{O1} = I_{O2} =$ full load		-	25	-	30	-	25

Table 6 Electrical Characteristics (to be continued)

Capacitive Load ( $\mu\text{F}$ )	$T_A = 25^\circ\text{C}$ , No effect on DC performance		-	10	-	100	-	10
Switching Frequency(kHz)	$I_o$ =full load		400	600	400	600	400	600
Step Load Response Transient(mV pK)	50% load to full load or full load to 50% load, Each $V_{out}$ has balanced load	Ambient temperature	-150	150	-450	450	-450	450
		high and low temperature	-500	500	-1400	1400	-1400	1400
	Each $V_{out}$ has balanced load	Ambient temperature	-150	150	-450	450	-450	450
		high and low temperature	-500	500	-1400	1400	-1400	1400
Step Load Response Recovery ( $\mu\text{s}$ )	50% load to full load or full load to 50% load, Each $V_{out}$ has balanced load	Ambient temperature	-	100	-	500	-	500
		high and low temperature	-	1000	-	4500	-	4500
	Each $V_{out}$ has balanced load	Ambient temperature	-	100	-	500	-	500
		high and low temperature	-	1000	-	4500	-	4500
Step Line Response Transient (mV pK)	$V_{in}$ =16~40V, $I_{o1}=I_{o2}$ =full load		-750	750	-500	500	-1500	1500
			-500	500			-1000	1000
Step Line Response Recovery ( $\mu\text{s}$ )	$V_{in}$ =16~40V, $I_{o1}=I_{o2}$ =full load		-	1200	-	750	-	1200
Load Fault Short Circuit recovery (ms)	$I_{o1}=I_{o2}$ short circuit to full load				-	2000		
			-	50	-	30	-	50

Notes to Specifications:

- ① The step load transition time should be greater than or equal to  $10\mu\text{s}$ .
- ② The step line transition time should be greater than or equal to  $10\mu\text{s}$ .
- ③ Recovery time is measured from application of the transient to point at which  $V_{OUT}$  is within 1% of  $V_{OUT}$  at final value.

## 4 TYPICAL PERFORMANCE CURVES of Mil Grade DC DC converters- HSA28 Series

(1) Single output model HSA28S5

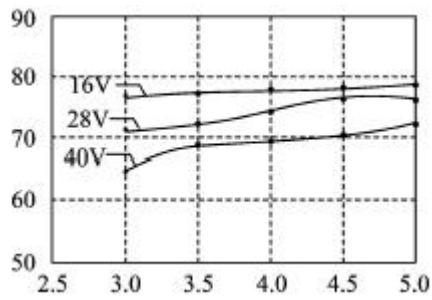

Figure 2 Efficiency (OUTPUT POWER)

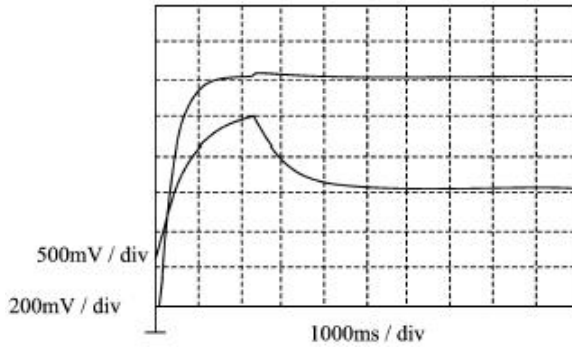

Figure 3 STEP LINE RESPONSE

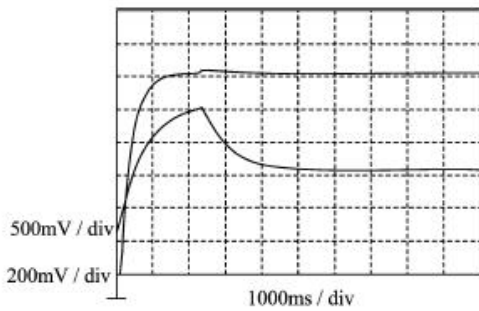

Figure 4 STEP LOAD RESPONSE

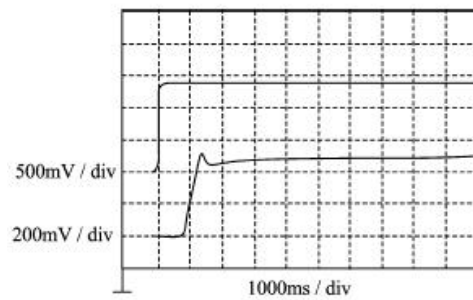

Figure 5 Start-up overshoot/ delay

(2) Dual output model HSA28D5

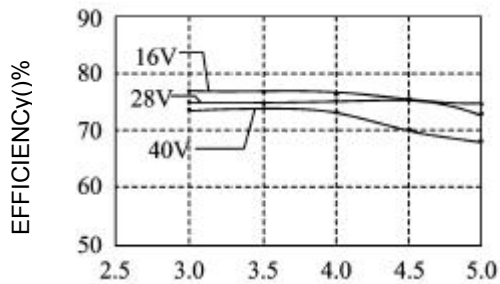

Figure 6 Efficiency (OUTPUT POWER)

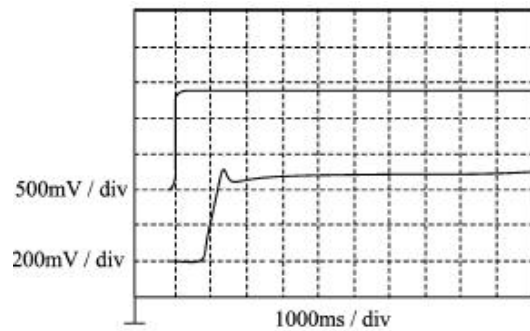

Figure 7 Input STEP LINE RESPONSE

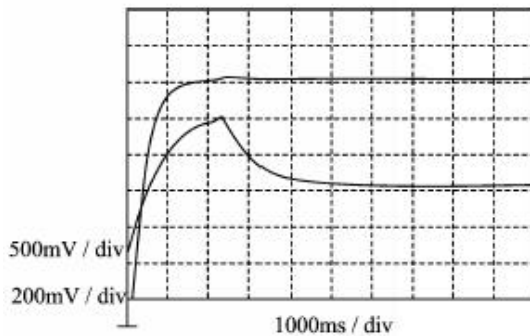

Figure 8 STEP LOAD RESPONSE

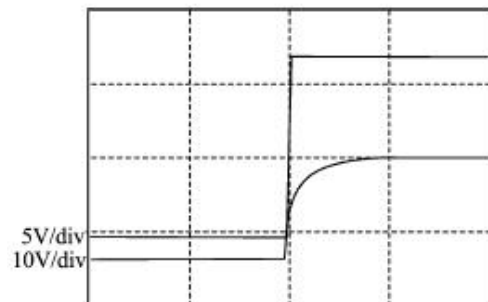

Figure 9 Start-up overshoot/ delay



## 5 TYPICAL MTBF CURVES of Mil Grade DC DC converters- HSA28 Series

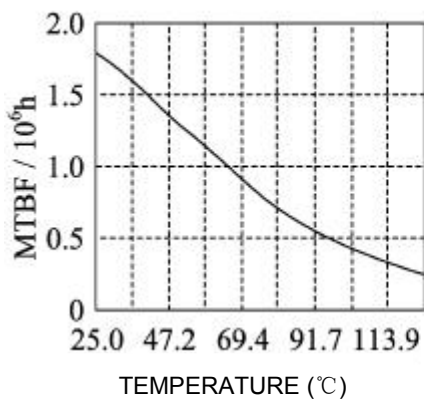

Figure10 Model HSA28 S15

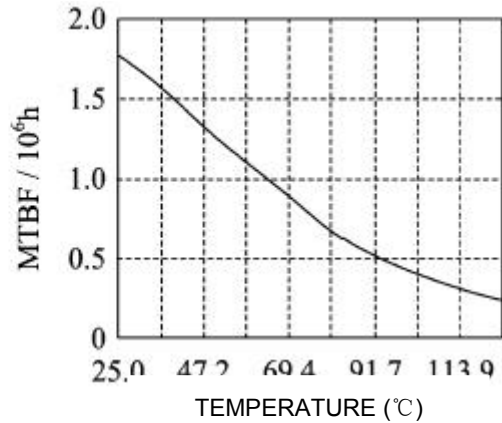

Figure 11 Model HSA28D15

## 6 TYPICAL CONNECTION DIAGRAM of Mil Grade DC DC converters- HSA28 Series

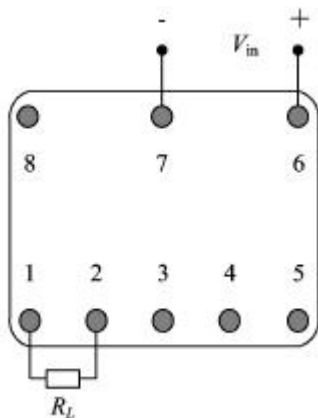

Figure12 Application Connection Diagram for Single output models

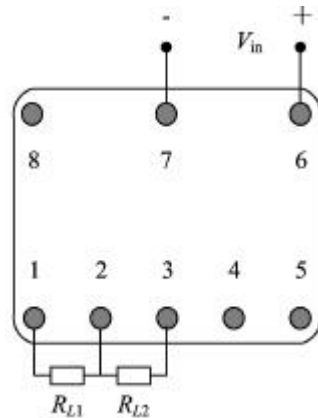

Figure13 Application Connection Diagram for Dual output models

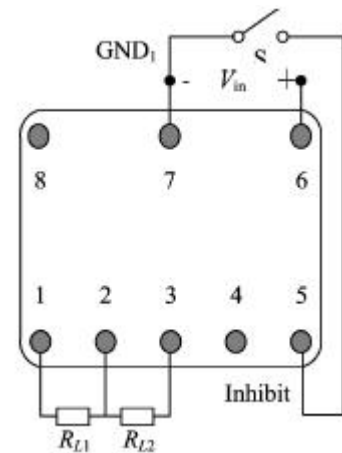

Figure14 Inhibit Drive connection Diagram for Single Output Models

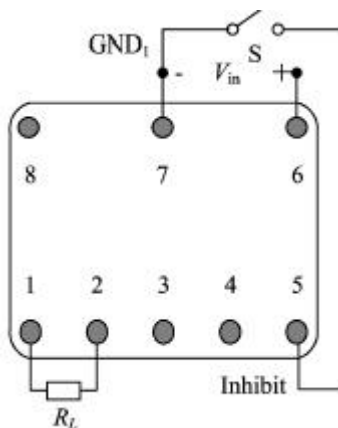

Figure15 Inhibit Drive connection Diagram for Dual Output Models

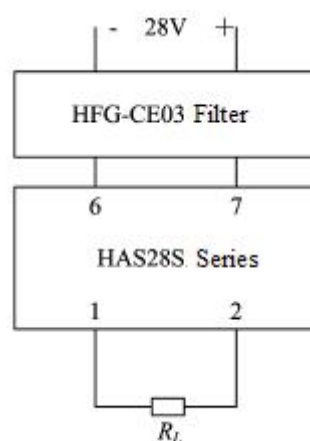

Figure16 Single Output Converter with EMI Filter Connection Diagram

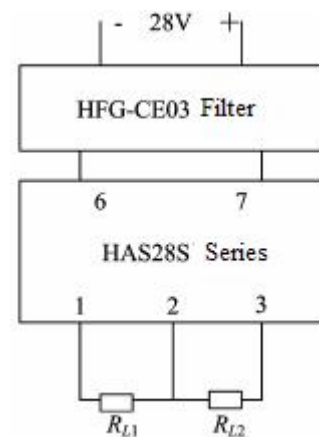
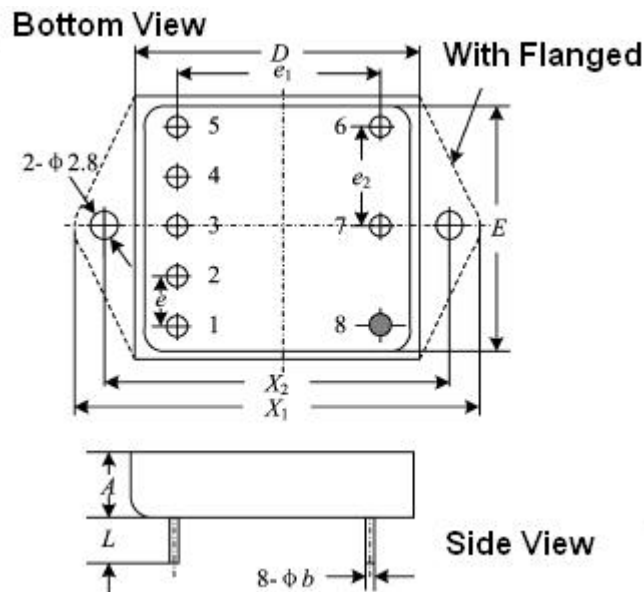

Figure17 Dual Output Converter with EMI Filter connection Diagram

## 7 PACKAGE SPECIFICATIONS of Mil Grade DC DC converters- HSA28 Series



Case Dimensions	Units /mm		
	Min	Typ	Max
A	—	—	6.86
$\phi b$	0.51	0.64	0.77
D/E	—	—	27.31
$e$	—	5.08	—
$e_1$	—	20.32	—
$e_2$	—	10.16	—
L	4.95	5.27	5.59
$X_1$	—	—	39.0
$X_2$	—	—	33.60

Figure18 Package Outline

Notes:

- ① Character “A” is 8.6 mm for HSA15S5, HSA28S3R3 and HSA28S2R5.
- ② Character “A” is 10 mm for HSA28S5 and HSA28S2R5-A

Table 6 Case Materials

Case Model	Header	Header Plating	Cover	Cover Plating	Pin	Pin Plating	Sealing Style	Notes
UPP2727-08f	Cold Rolled Steel	Nickel/Gold	Iron/Nickel Alloy	Nickel/Gold	Copper Compound	Nickel/Gold	Compression Seal	Nickel plating is for pin8.

Notes:Solder pins individually with heat application not exceeding 300°C for 10 seconds per pin.

## 8 PIN DESIGNATION of Mil Grade DC DC converters- HSA28 Series

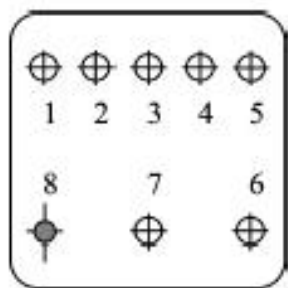

Figure19 Pin Out Bottom View

Pin	Single Output	Dual Output
1	Positive Output	Positive Output
2	Output Common	Output Common
3	No connection	Negative Output
4	No connection	No connection
5	Inhibit	Inhibit
6	Positive Input	Positive Input
7	Input Common	Input Common
8	Case Ground	Case Ground

## 9 ORDERING INFORMATION of Mil Grade DC DC converters- HSA28 Series

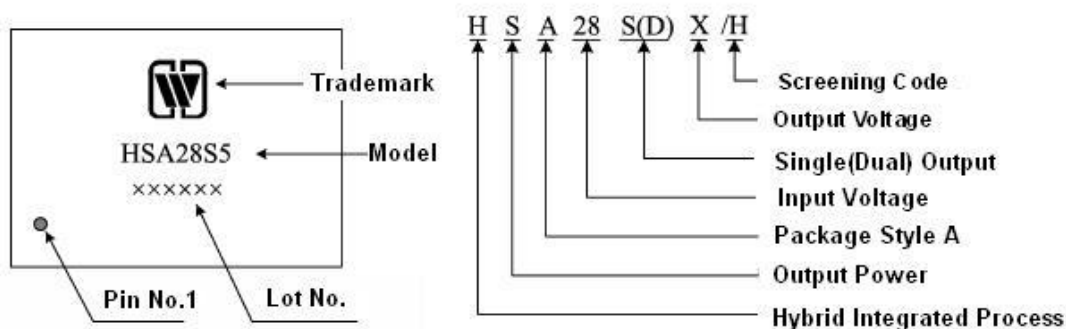

Figure 20 Part Numbering Key

### Application Notes:

- The correct power supply is to be ensured that may not cause permanent damage to the device.
- When the electrical performance is tested, the testing position should be pin of the device.
- When the device is mounted, the bottom of the device should be closely attached to the circuit board. So as to avoid the damage of the pins, the shockproof should be increased when it is required
- The pin should not be bending to avoid the glass insulator breaking and case leakage.
- When the case temperature is at 105°C, it is suggested that thickness of the thermal sinking plate(copper material) is 3mm, the dimension is greater than 100mm×100mm.
- When the case temperature is at 125°C, it is suggested that thickness of the thermal sinking plate is 3mm, the dimension is greater than 120mm×80mm.

To request a quotation or place orders ,please contact our sales representative or the ECRIM Sales  
 Department at: Sales Phone: (086) 0551-3667943 Sales Fax: (086) 0551-3638101  
 E-mail: sales@ecrim.cn