

# Digital-to-synchro/resolver converter (HDRC14-16 series)

## 1. Features (for outside view, see Fig. 1)

- 14-bit and 16-bit resolution
- 4' and 2' accuracy
- 2VA output drive capacity
- Low radius vector error (0.03%)
- Equipped with overvoltage protection and short-circuit protection
- Provided with telemetric output pin
- Without the need of external adjustment
- Pin-to-pin compatibility with DRC1745/1746 product of AD company



Size: 54.36x27.92x5.5mm<sup>3</sup>; weight: 29g

Fig.1 Outside view of HRDC14-16 series

## 2. Scope of application

Drive synchro/resolver; antenna system; servo system; integrated navigation system; cannon control system; aircraft and warship simulator.

## 3. Description

HDRC14/HDRC16 series product is digital to resolver converter of hybrid integrated circuit structure equipped with built-in power amplifier which can drive 2VA load. The load can be inductive load, capacitive load or resistive load, and it is provided with overcurrent and overvoltage protection. The output of converter can directly drive the resolver, and can also drive the control transformer of synchro by connecting a, external transformer. The unique performance of HDRC14/HDRC16 series product is sine and cosine telemetric output. Thus, when performing long-line drive, it can ensure the precision of converted output signal. HDRC14/HDRC16 series products are equipped with internal latch, which is controlled through high bit enable end HBE and low bit enable end LBE, and can be connected with data bus conveniently. HDRC14/HDRC16 series products are dual in-line 40-pin metal package.

## 4. Electrical performance (Table 1, Table2)

Table 1 Rated conditions and recommended operating conditions		Table 2 Electric characteristics						
Absolute max. rated value	Supply voltage $V_s$ : $\pm 7.25V$ Logic voltage $V_L$ : $+5.5V$ Storage temperature range: $-65 \sim +150$	Characteristic	HDRC14		HDRC16		Unit	Remarks
			Min.	Max.	Min.	Max.		
Recommended operating conditions	Supply voltage $V_s$ : $\pm 5V$ Logic voltage $V_L$ : $+5V$ Reference frequency $f$ : 400Hz~2000Hz Range of operating temperature $T_A$ : $-55 \sim 125$	Resolution	-	14	-	16	bit	
		Angle error	-	$\pm 5.3$	-	$\pm 2$	Angular minute	
		Analogue reference input	3.23	3.57	3.23	3.57	V	
		Signal output of resolver	6.46	7.14	6.46	7.14	V	
		Gain ( $V_{Ref}-V_o$ )	1.999	2.001	1.999	2.001	V	
		Temperature coefficient of output gain	-	25	-	25	PPM/	
		Analogue input frequency range	0	2.6	0	2.6	kHz	
		Analogue input impedance	10.2	-	15.9	-	k $\Omega$	
		Analogue output impedance	-	0.2	-	0.2	$\Omega$	
		Output power	-	2	-	2	VA	

Radius vector error	-	±0.03%	-	±0.03%	-
Type of digital input	Parallel binary code (TTL level)		Parallel binary code (TTL level)		-

### 5. Circuit block diagram (Fig. 2)

The reference voltage  $V_{Ref}(A\sin\omega t)$  is multiplied by  $\sin\theta$  and  $\cos\theta$ , then transmitted to current amplifier through bus, thus an output voltage required by the converter is obtained.

i.e.:  $2A\sin\omega t\sin\theta$  (sin output)

$2A\sin\omega t\cos\theta$  (cos output)

Where,  $\theta$  is the input digital angle.

(Note: the converter obtains 2 times gain from input to output. "GND" and "sinGND" in Fig. 2 are internal connection.)

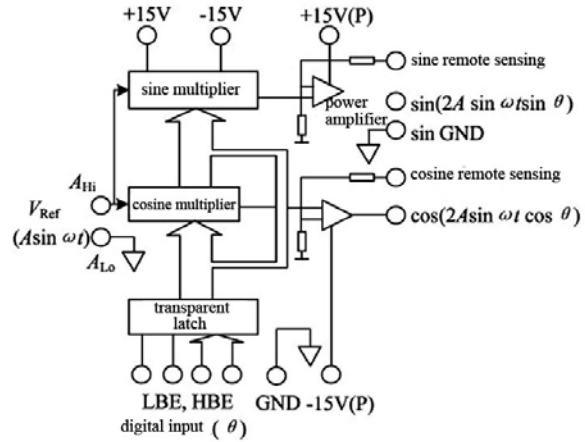

Fig. 2 Circuit block diagram

### Power consumption

At the output stage, common DC power or pulsating power can be used. There is a very low flat top of DC voltage for the pulsating voltage of pulsating power, which reduces the power consumption. At 2VA load, even if the voltage of flat-topped pulsating power is as low as 2~3V, it can also ensure normal operation.

The pulsating power is only used for the gain of supply current at output stage, the total gain of operating circuit in the device does not depend on the power supply, therefore, the conversion accuracy of the device over the full scale range keeps unchanged during the operating period of pulsating power.

Below we will illustrate that when using DC power and pulsating power, the power consumption is different for different load.

#### (1) DC power supply

For DC power supply, the power consumption related to load is:

$$P = \frac{2V_{DC}I_1}{\pi}(|\sin\theta| + |\cos\theta|) - \frac{V_{out}I_1\cos\alpha}{2}$$

Where,  $V_{out}$  is the peak value of output voltage;  $I_1$  is the peak value of output load current;  $\theta$  is the digital angle;  $\alpha$  is the phase angle of load;  $V_{DC}$  is the voltage of DC power, which is normally  $\pm 15V$ .

#### (2) Pulsating power supply

When using pulsating power supply, the power consumption related to load is:

$$P = \frac{2V_p I_1}{\pi}(|\sin\theta| + |\cos\theta|) - \frac{V_{AC} I_1}{\pi}(\sin\alpha - \cos\alpha)$$

Where,  $V_{AC}$  is the AC component of pulsating voltage, which is assumed to be equal to the peak value  $V_{out}$  of output voltage;  $I_1$  is the peak value of output load current;  $\theta$  is the digital angle;  $\alpha$  is the phase angle of load;  $V_p$  is the flat top of pulsating power.

Note:  $I_1 = \frac{V_{out}}{|Z|}$

Where,  $V_{out}$ =peak value of output voltage= $2 \times V_{Ref}$ ;  
 $Z$ =output load

#### (3) Example of power consumption

There are many factors that influence the power consumption, the following four examples use typical loads and the worst digital angle state ( $45^\circ$ ). These examples can illustrate that using pulsating power can reduce the power consumption.

Here, the operating conditions are:

$V_{DC}=\pm 15V$ ;  $V_p=3V$ ;  $V_{out}=9.6V$  (RMS value is 6.8V);  $V_{AC}=9.6V$  (approximately equal to  $V_{out}$ );  $I_1=292mA$  (equivalent to a load which requires 1.4VA).

DC power supply,  $\theta=45^\circ$ , resistive load

$$P = \frac{2 \times 15 \times 0.292(\sin 45^\circ + \cos 45^\circ)}{\pi} - \frac{9.6 \times 0.292 \times 1}{2} = 3.943 - 1.402 = 2.54W$$

Same as example 1, the power supply is 3V pulsating power supply.

$$P = \frac{2 \times 3 \times 0.292(\sin 45^\circ + \cos 45^\circ)}{\pi} - \frac{9.6 \times 0.292 \times 0}{\pi} = 0.79 \text{ W}$$

When using the pulsating power, the internal power consumption is reduced by 1.75W, their ratio is 3.2:1.

DC power supply,  $\theta=45^\circ$ , pure inductive load

$$P = \frac{2 \times 15 \times 0.292(\sin 45^\circ + \cos 45^\circ)}{\pi} - \frac{9.6 \times 0.292 \times 0}{2} = 3.94 \text{ W}$$

Same as example 3, the power supply is 3V pulsating power supply.

$$P = \frac{2 \times 3 \times 0.292(\sin 45^\circ + \cos 45^\circ)}{\pi} - \frac{9.6 \times 0.292 \times 1}{\pi} = 1.68 \text{ W}$$

#### (4) Load

Next, we will illustrate how to calculate the load. For the control transformer of synchro, first it is required to obtain the value of  $Z_{so}$ , which is generally provided by the synchro manufacturer. The control load is:

$$\frac{3}{4} \times V^2 Z_{so}$$

Where,  $V^2$  is the RMS value of signal voltage.

If an output transformer is added at the output pin, then 0.25VA shall be added to the calculated power.

For example, assume that the RMS value of signal is 90V, 400Hz, use HRDC14 external output transformer to drive the control transformer of synchro. Use of external transformer is to increase the RMS value of voltage output of HRDC14 from 6.8 V to 90V required by the control transformer.

For the control transformer of synchro,  $Z_{so}$  is  $700+j4900$ .

$$|Z_{so}| = \sqrt{700^2 + 4900^2} = 4950 \Omega$$

Therefore, the load when using the control transformer is:  $\frac{90^2 \times \frac{3}{4}}{4950} = 1.23 \text{ VA}$ ; then plus the additional power consumption of the transformer, the total power consumption is 1.48VA.

This method can also be used for the application that uses the rotary control transformer, but it does not need to be multiplied by 3/4.

## 6. MTBF curve (Fig. 3)

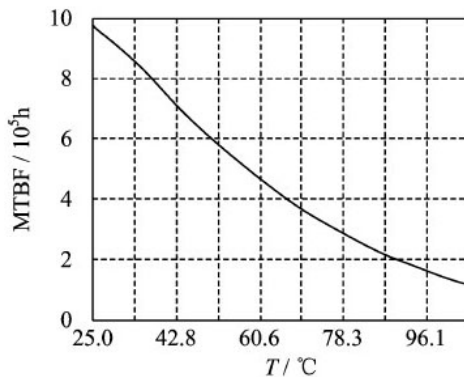

Fig. 3 MTBF-temperature curve

(Note: according to GJB/Z299B-98, envisaged good ground condition)

## 7. Pin designation (fig.4, Table 3)

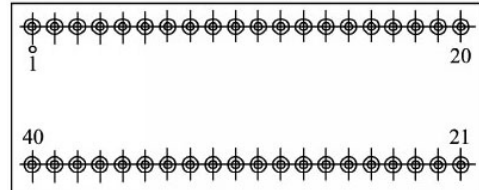

Fig.4 Schematic diagram of pin (bottom view)

Table 3 Functional description of pins

Pin	Symbol	Function	Pin	Symbol	Function	Pin	Symbol	Function
1	D <sub>1</sub> (MSB)	1 <sup>st</sup> bit digital input	13	D <sub>13</sub>	13 <sup>th</sup> bit digital input	28	GND <sub>A</sub>	Analog ground
2	D <sub>2</sub>	2 <sup>nd</sup> bit digital input	14	D <sub>14</sub> (LSB)	14 <sup>th</sup> bit digital input	29	V <sub>-</sub>	-15V Power supply
3	D <sub>3</sub>	3 <sup>rd</sup> bit digital input	15	D <sub>15</sub>	15 <sup>th</sup> bit digital input	30	V <sub>+</sub>	+15V Power supply
4	D <sub>4</sub>	4 <sup>th</sup> bit digital input	16	D <sub>16</sub> (LSB)	16 <sup>th</sup> bit digital input	31	V <sub>1+</sub>	+5V Power supply
5	D <sub>5</sub>	5 <sup>th</sup> bit digital input	17-20	NC	No connection	32	LE	Low 8-bit select enabled
6	D <sub>6</sub>	6 <sup>th</sup> bit digital input	21	V <sub>cos</sub>	Cosine output end	33	HE	High 8-bit select enabled
7	D <sub>7</sub>	7 <sup>th</sup> bit digital input	22	V <sub>sin</sub>	Sine output end	34	R <sub>L0</sub>	Low end of reference input

8	D <sub>8</sub>	8 <sup>th</sup> bit digital input	23	V <sub>+P</sub>	+15V pulsating power	35	R <sub>Hi</sub>	High end of reference input
9	D <sub>9</sub>	9 <sup>th</sup> bit digital input	24	V <sub>-P</sub>	-15V pulsating power	36	Case	Case ground
10	D <sub>10</sub>	10 <sup>th</sup> bit digital input	25	cos telemetry	Cosine telemetric end	37-40	NC	No connection
11	D <sub>11</sub>	11 <sup>th</sup> bit digital input	26	sin telemetry	Sine telemetric end			
12	D <sub>12</sub>	12 <sup>th</sup> bit digital input	27	GND <sub>S</sub>	Signal ground			

Notes: the digital input pin D<sub>1</sub>~D<sub>16</sub> of converter are directly connected with the clear latch for buffer in the converter.

“HBE” controls high 8-bit input and “LBE” controls low-bit input, respectively low 6-bit for HDRC14 and low 8-bit for HDRC 16.

When “HBE” and “LBE” are set to logic “1”, the latch is clear, at this time, the output of converter varies with the change of input data. When “HBE” and “LBE” are set to logic “0”, due to the latching of data at input pin, the data of converter will keep unchanged, until “HBE” and “LBE” are set to logic “1” again. If the latching function is not required, then “HBE” and “LBE” can be open-circuit.

All digital input pins have 27kΩ pull-up resistance inside to be connected with 5V power supply, thus, if 50μA current on any latch input pin leaks to the external digital drive, it can still ensure all input pins compatible with TTL level are stable.

### 8. Table of weight values (Table 4)

Table 4 Table of weight values

Bit/(MSB)	Angle	Bit/(MSB)	Angle	Bit/(MSB)	Angle
1	180.000 0	7	2.812 5	13	0.043 9
2	90.000 0	8	1.406 3	14 (for 14-bit LSB)	0.022 0
3	45.000 0	9	0.703 1	15	0.011 0
4	22.500 0	10	0.351 6	16 (for 16-bit LSB)	0.005 5
5	11.250 0	11	0.175 8		
6	5.625 0	12	0.087 9		

### 9. Connection diagram for typical application (Fig. 5)

(1) Signal output type of resolver

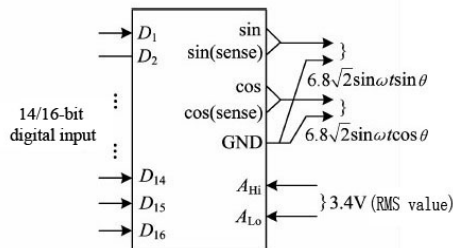

(2) Signal output type of synchro (fig.5)

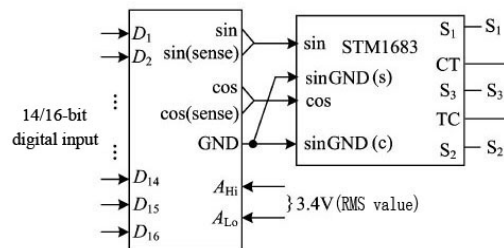

Note: for other voltage output, it is needed to connect an isolation transformer after it (e.g. RTM1683).

Fig. 5

Connection diagram for typical application

### 10. Connection of converter (Fig. 6)

The connection of HDRC14/HDRC16 series product is very direct, i.e. the digital input conforming to the stipulated format in the table of weight values are directly connected to 1(MSB)~14(LSB) of HDRC14 or 1(MSB)~16(LSB) of HDRC16.

A<sub>Lo</sub> and A<sub>Hi</sub> are reference voltage input.

The output amplifier of converter has independent power supply +15V(P) and -15V(P), it is a pulsating power supply, but it can also use DC power supply.+15V and -15V power supply of converter must be DC power supply.

There is a 0.47μF decoupling capacitance between

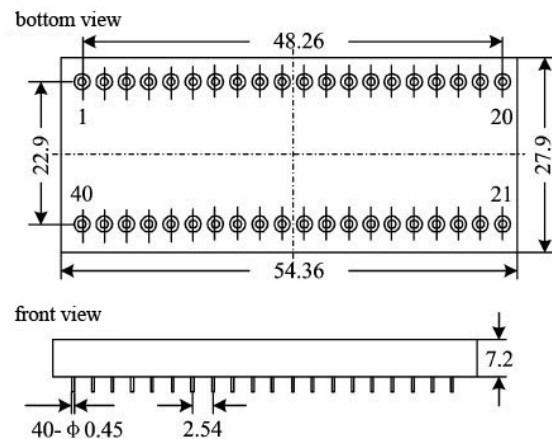

Fig. 6 Outside view and dimensions of package

power supplies of power amplification stage inside the converter, but we still recommend to connect a 6.8μF decoupling capacitance between +15V, -15V and GND.

Case means case ground, which can be connected to the suitable zero potential in the system.

The sin and cos signals are provided by “sin output” and “cos output”. The “sin telemetry” and “cos telemetry” can be directly used, if not, they shall be connected with corresponding sin output pin and cos output pin.

**11. Package specifications** (unit: mm) (Fig. 7, Table 5)

Table 5 Case materials

Case model	Header	Header plating	Cover	Covering plating	Pin material	Pin plating	Sealing style	Notes
UP5428-40	Kovar (4J29)	Ni/Au	Iron/nickel alloy (4J42)	Ni/Au	Kovar (4J29)	Ni/Au	Matched seal	

Note: temperature of the solder pins within 10s shall not exceed 300 .

**12. Part number key** (Fig. 7)

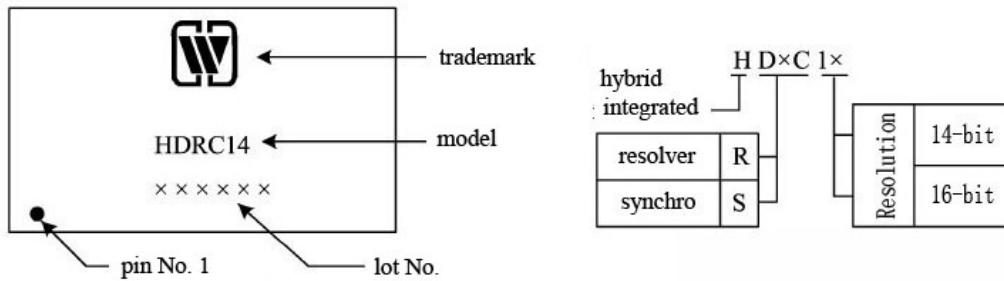

Fig. 7 Part numbering key

**Application notes:**

The voltage of power supply shall not exceed the specified range.

Do not connect reference R<sub>Hi</sub> and R<sub>Lo</sub> to other pins.

Supply the power correctly, upon power-on, be sure to correctly connect the positive and negative pole of the power supply for fear of burning.

Upon assembly, the bottom of the product shall fit to the circuit board closely so as to avoid damage of pins, and shockproof provision shall be added, if necessary.

Do not bend the pinouts to prevent the insulator from breaking, which affects the sealing property.

When the user places an order for the product, detailed electric performance indexes shall refer to the relevant enterprise standard.