

Digital-to-synchro/ resolver converter (MDSC/MDRC38 series)

1. Product characteristics (see Fig. 1 for outside view, and Table 1 for types)

12-bit, 14-bit and 16-bit resolution
8.5°, 4.0°, 2.6° accuracy
1.3VA output drive capacity
Compatible with DTL/TTL/COMS level

Output power is 1.5 W

Table 1 product models

MDRC3814-42-4/7



Size: 50.8×50.8×21mm³; weight: 106g

Fig. 1 Outside view of MDRC/MDSC38 series

2. Scope of application

Military servo control system
Antenna system
Radar measurement system
Navigation system
Cannon control system
Machine tool control

3. Description

MDSC/MDRC29 series are the converter that converts the input binary signal into sin and cos signal output. Input signal is compatible with DTL/TTL/CMOS level, the output signal is orthogonal sin and cos signal which can directly drive isolation transformer or SCOTT transformer, then, is converted into arbitrary value of resolver or synchro signal. This series of product continuously tracks the input 12-bit/14-bit/16-bit binary data, and outputs high-precision synchro/resolver signal after conversion, it has higher conversion accuracy and latch function. The product is equipped with power amplification circuit inside it, and its output power can reach 1.3W.

Table 2 Rated conditions and recommended operating conditions

	Supply voltage + V_S : 13.5~17.5V
Absolute max. rated value	Supply voltage - V_S : -17.5~-13.5V
	Signal voltage V_I^* : 7V±10%
	Reference voltage V_{Ref} : 4V±10%;
	Operating frequency f^* : 50Hz±10%
	Storage temperature range: -40~100°C

Recommended operating condition	Supply voltage + V_S : 14.25~16.5V
	Supply voltage - V_S : -14.25~-16.5V
	Signal voltage V_I^* : 7V±5%
	Reference voltage V_{Ref} : 4V±5%
	Operating frequency f^* : 50Hz±10%
	Storage temperature range(T_A): -40~85°C

Note: * indicates it can be customized as per user's requirement.

4. Technical performance (Table 2, Table2)

Table 3 Electric characteristics

Parameter	Conditions (unless otherwise specified, -40°C ≤ T_A ≤ 85°C V_+ = 15V±5% V_- = -15V±5%)	MDRC381X-42-4/7 Enterprise military standard (Q/HW30832-2006)		Unit
		Min.	Max.	
		Resolution/RES	12-bit converter	
	14-bit converter	14		bit
		16		bit

Output precision/r	12-bit	-8.5	8.5	angular minute
	14-bit	-4	4	
	16-bit	-2.6	2.6	

Signal output voltage/ V_o	T_A = 25°C	6.65	7.35	V
Input high level	T_A = 25°C	2.4	-	V
Input low level	T_A = 25°C	-	0.8	V
Output load capacity/ P_o	T_A = 25°C	1.3	-	W

5 Operating principle(Fig. 2)

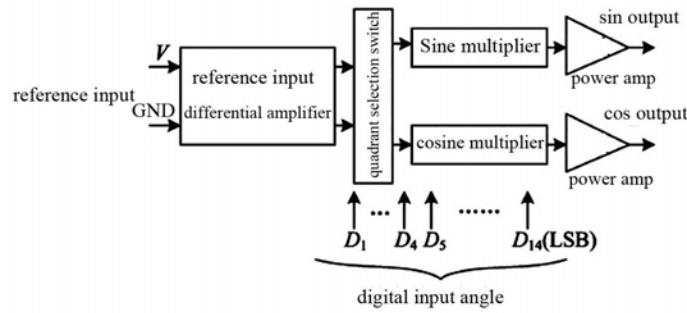

Fig. 2 Operating block diagram

6 MTBF curve(Fig. 3)

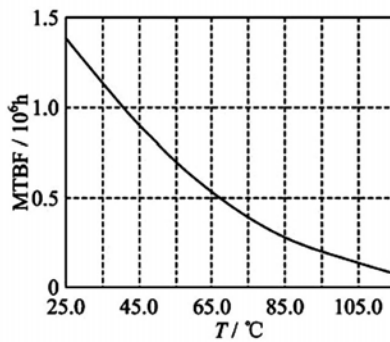

Fig. 3 MTBF-temperature curve

(Note: as per GJB/Z299B-98, envisaged good ground condition)

7 Pin designation(Fig. 4, Table 4)

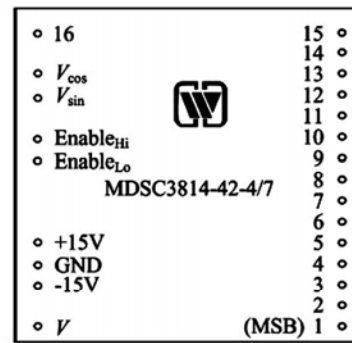

Fig. 4 Top view

Table 4 Pin designation

Pin	Symbol	Meaning	Pin	Symbol	Meaning	Pin	Symbol	Meaning
1	D_1	digital input 1 (MSB)	11	D_{11}	digital input 11	21	$Enable_{Lo}$	low 6 bits Enable
2	D_2	digital input 2	12	D_{12}	digital input 12	22	$Enable_{Hi}$	high 8 bits Enable
3	D_3	digital input 3	13	D_{13}	digital input 13	23	NC	leave unconnected
4	D_4	digital input 4	14	D_{14}	digital input 14	24	NC	leave unconnected
5	D_5	digital input 5	15	D_{15}	digital input 15 (unconnected for 12 & 14-bit)	25	NC	leave unconnected
6	D_6	digital input 6	16	D_{16}	digital input 16 (unconnected for 12 & 14-bit)	26	$+V_s$	+15V power supply
7	D_7	digital input 7	17	NC	leave unconnected	27	GND	power ground
8	D_8	digital input 8	18	V_{cos}	cos signal output	28	$-V_s$	-15V power supply
9	D_9	digital input 9	19	V_{sin}	sin signal output	29	NC	leave unconnected
10	D_{10}	digital input 10	20	NC	leave unconnected	30	V	excitation input

Note: ① If it is output of rotary resolver, pin 17~20 are $S_1 \sim S_4$; if it is output of synchro, pin 20 is vacant.

8 Table of weight values(Table 5)

Table 5 Table of weight values

Bit number (MSB)	Angle	Bit number(MSB)	Angle	Bit number(MSB)	Angle
1	180.000 0	7	2.812 5	12(for 12-bit LSB)	0.087 9
2	90.000 0	8	1.406 3	13	0.043 9
3	45.000 0	9	0.703 1	14(for 14-bit LSB)	0.022 0
4	22.500 0	10	0.351 6	15	0.011 0
5	11.250 0	11	0.175 8	16(for 16-bit LSB)	0.005 5
6	5.625 0				

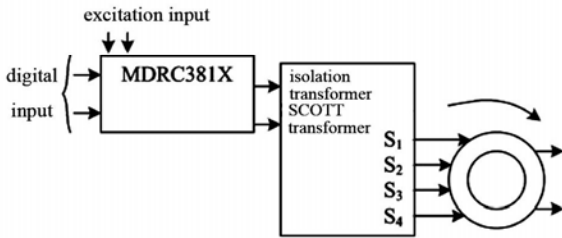

Fig. 5 Diagram for connection of MDRC381X with resolver and Synchro

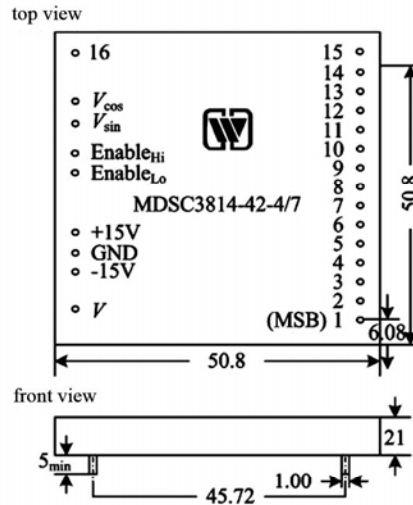

Fig. 6 Outside view and dimensions of package

11 Part numbering key (Fig. 7)

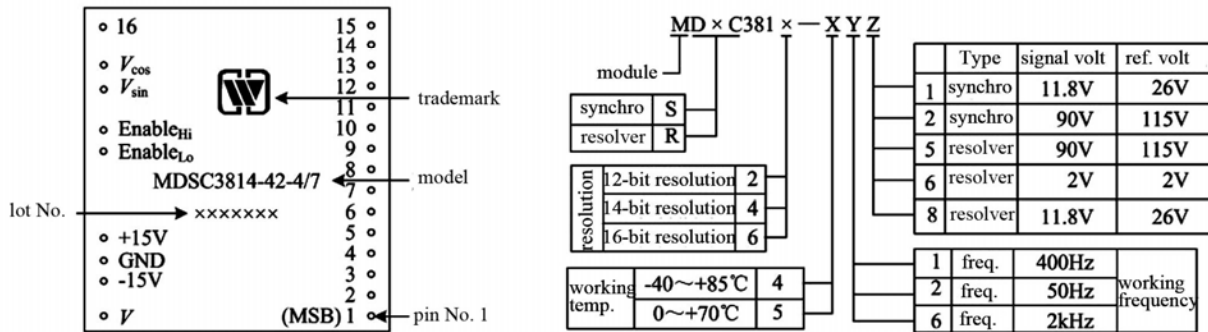
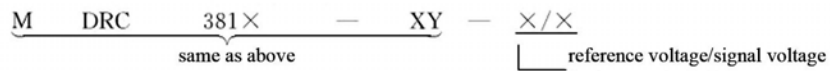

Fig. 7 Part numbering key

Notes: ① When above signal voltages and reference voltages(Z) are non-standard, they are given as follows:



(e.g.: reference is 5V and signal voltage is 3V, then expressed as: -5/3)

② Placed outside for 50Hz product transformer.

Application notes

- ★ Supply the power correctly, during the power-up, correctly connect the positive and negative poles of power to avoid burning.
- ★ Upon assembly, the bottom of the product shall fit to the circuit board closely so as to avoid damage of pins, and shockproof provision shall be added, if necessary.
- ★ When the user places an order for the product, detailed electric performance indexes shall refer to the relevant enterprise standard.