

Mil-cots DC DC converters-HTR28 Series

1 FEATURES of Mil-cots DC DC converters-HTR28 Series

- 16 to 40 VDC input, typical 28V
- 30W output power
- -55°C to+125°C operation
- Fully isolated
- 100M Ω minimum (500V DC) isolation
- Inhibit and indefinite short circuit protection
- 30W/in³ power density
- Equivalent with Interpoint's MTR Series
- Hermetically sealed metal cases



Size: 53.98×28.58×10.16mm³(non-flanged)
 73.91×28.58×10.16mm³(flanged)
 Triple Output Models:
 49.53×34.29×10.29mm³(non-flanged)
 69.09×34.29×10.29mm³ (flanged)
 Weight: 52 grams (non-flanged)
 60 grams (flanged)

Figure 1 HTR28 series DC/DC converters

Table 1 Product models

MODELS		
SINGLE	DUAL	TRIPLE
HTR28S5(F)	HTR28D5(F)	HTR28T512(F)
HTR28S12(F)	HTR28D12(F)	HTR28T515(F)
HTR28S15(F)	HTR28D15(F)	HTR28T515-A
HTR28S3R3		HTR28T515-B
HTR28S18(F)		

2 DESCRIPTION of Mil-cots DC DC converters-HTR28 Series

The HTR28 Series of DC/DC converters offer up to 30 watts of output power with high reliability. The converters are packaged in hermetically sealed metal cases, making them ideal for use in aviation, aerospace and other high reliability applications.

The HTR 28 series of converters use a single ended, pulse width modulated and transformer magnetic feedback topology design. The operating principle is that the sampling signal of output voltage , coupled by the opto-coupler, works together with the sampling signal of input loop current to regulate the pulse width of the controller. The double close loop control create constant voltage output and short circuit protection.

Thick film hybrid techniques provide the HTR 28 Series of converters with reliability levels and optimum miniaturization. The design and manufacturing process of HTR 28 Series of converters are in compliance with General Standards of Hybrid Integrated Circuits and detailed standards of manufacturing. Connected to a HFD-CE03 filter, the HTR 28 Series of converters can achieve

3 ELECTRICAL PERFORMANCE of Mil-cots DC DC converters-HTR28

Series

ABSOLUTE MAXIMUM RATINGS	
•	Input Voltage: 16 to 40 VDC
•	Power Dissipation: 30 watts
•	Lead Soldering Temperature:300°C(10s)
•	Storage Temperature Range: -55°C to+125°C
•	Inhibit Voltage: 0.2V max
•	External Synchronous Signals:
	Frequency Range: 450k to 600kHz
	Duty Ratio: 40% to 60%
	Level: 0.8 V≤V≤4.5V
RECOMMENDED OPERATING CONDITIONS	
•	Input VDC: 16 to 40 V
•	Case Temperature(Tc): -55°C to+125°C

HTR28S5(F) , HTR28S12(F) , HTR28S15(F)

Table 2 Electrical Characteristics: (T_{CASE} = -55°C to +125°C, V_{IN} = 28V ± 0.5V, Full Load_s, Unless Otherwise Specified)

Single output models			HTR28S5(F)		HTR28S12(F)		HTR28S15(F)	
Parameter	Conditions		Min	Max	Min	Max	Min	Max
Output Voltage(V)	<i>I</i> _o =full load	Ambient temperature high and low temperature	4.95 4.85	5.05 5.15	11.88 11.64	12.12 12.36	14.85 14.55	15.15 15.45
Output Current(A)	<i>V</i> _{in} = 16 TO 40 VDC		—	5	—	2.5	—	2
Output Power(W)	—		—	25	—	30	—	30
Output Ripple Voltage (mV)	<i>BW</i> =10 kHz to 2 MHz <i>I</i> _o =full load	Ambient temperature high and low temperature	—	50 90	—	40 90	—	40 90
Line Regulation (mV)	<i>V</i> _{in} = 16 TO 40 VDC, <i>I</i> _o =full load		—	50	—	50	—	50
Load Regulation (mV)	<i>I</i> _o =No load to load		—	50	—	50	—	50
Input Ripple Current (mA)	<i>BW</i> =10 kHz to 10 MHz <i>I</i> _o =full load		—	50	—	50	—	50
Efficiency (%)	<i>I</i> _o =full load	Ambient temperature high and low temperature	76 73	—	80 77	—	80 78	—
Isolation (MΩ)	Input to output or any pin to case (except pin7,8) at 500 VDC, <i>T</i> _A = 25° C		100	—	100	—	100	—
Inhibit Function	<i>T</i> _A = 25° C, Inhibit voltage, output disabled		yes		yes		yes	
Protection Function	<i>T</i> _A = 25° C		yes		yes		yes	
Start-up Overshoot (mV pk)	<i>V</i> _{in} =0 to 28V, <i>I</i> _o =full load		—	50	—	120	—	150
Start-up Delay (ms)	<i>V</i> _{in} =0 to 28V, <i>I</i> _o =full load		—	5	—	5	—	5
Capacitive Load	<i>T</i> _A = 25° C, No effect on DC performance		—	300	—	3000	—	3000

(to be continued) **Table 2 Electrical Characteristics**

Switching Frequency(kHz)	I_o =full load	400	600	400	600	400	600
Step Load Response Transient (mV pK)	50% load -- full load -50% load	-300	300	-400	400	-500	500
Step Load Response Recovery (μ s)	50% load -- full load -50% load	—	200	—	200	—	200
Step Line Response Transient (mV pK)	V_{in} =16~40V, I_o =full load V_{in} =40~16V, I_o =full load	-300	300	-500	500	-600	600
Step Line Response Recovery (μ s)	V_{in} =16~40V, I_o =full load V_{in} =40~16V, I_o =full load	—	300	—	300	—	300
Load Fault Short Circuit recovery (ms)	short circuit to full load	—	5	—	5	—	5

Notes to Specifications:

- ① The step load transition time should be greater than or equal to 10 μ s.
- ② The step line transition time should be greater than or equal to 10 μ s.
- ③ Recovery time is measured from application of the transient to point at which V_{OUT} is within 1% of V_{OUT} at final value.

HTR28S3R3 ,HTR28S18

Table3 Electrical Characteristics: ($T_{CASE} = -55^{\circ}C$ to $+125^{\circ}C$, $V_{IN} = 28V \pm 0.5V$, Full Load₅, Unless Otherwise Specified)

Single output models		HTR28S3R3		HTR28S18	
Parameter	Conditions	Min	Max	Min	Max
Output Voltage (V)	I_o =full load Ambient temperature high and low temperature	3.267 3.201	3.333 3.399	17.82 17.46	18.18 18.54
Output Current(A)	$V_{in} = 16$ TO 40 VDC	—	6.06	—	1.67
Output Power(W)	—	—	20	—	30
Output Ripple Voltage (mV)	$BW=10$ kHz to 2 MHz I_o =full load Ambient temperature high and low temperature	—	40 50	—	40 90
Line Regulation(mV)	$V_{in} = 16$ TO 40 VDC, I_o =full load	—	10	—	50
Load Regulation(mV)	I_o =No load to load	—	10	—	50
Input Ripple Current(mA)	$BW=10$ kHz to 10 MHz, I_o =full load	—	50	—	50
Efficiency (%)	I_o =full load Ambient temperature high and low temperature	74 71	—	81 78	—
Isolation (M Ω)	Input to output or any pin to case (except pin7,8) at 500 VDC, $T_A = 25^{\circ}C$	100	—	100	—
Inhibit Function	$T_A = 25^{\circ}C$, Inhibit voltage, output disabled	yes		yes	
Protection Function	$T_A = 25^{\circ}C$	yes		yes	
Start-up Overshoot (mV pK)	$V_{in}=0$ to 28V, I_o =full load	—	50	—	180
Start-up Delay(ms)	$V_{in}=0$ to 28V, I_o =full load	—	5	—	5
Capacitive Load(μ F)	$T_A = 25^{\circ}C$, No effect on DC performance	—	300	—	2000
Switching Frequency(kHz)	I_o =full load	400	600	400	600
Step Load Response Transient (mV pK)	50% load -- full load -50% load	-250	250	-600	600
Step Load Response Recovery (μ s)	50% load -- full load -50% load	—	200	—	200
Step Line Response Transient (mV pK)	V_{in} =16~40V, I_o =full load, V_{in} =40~16V, I_o =full load	-300	300	-800	800
Step Line Response Recovery (μ s)	V_{in} =16~40V, I_o =full load, V_{in} =40~16V, I_o =full load	—	300	—	300
Load Fault Short Circuit recovery (ms)	short circuit to full load	—	5	—	5

Notes to Specifications:

- ① The step load transition time should be greater than or equal to 10 μ s.
- ② The step line transition time should be greater than or equal to 10 μ s.
- ③ Recovery time is measured from application of the transient to point at which V_{OUT} is within 1% of V_{OUT} at final value.

HTR28D5(F), HTR28D12(F), HTR28D15(F)

Table 4 Electrical Characteristics: (T_{CASE} = -55°C to +125°C, V_{IN} = 28V \pm 0.5V, Full Load₅, Unless Otherwise Specified)

Dual output models			HTR28D5(F)		HTR28D12(F)		HTR28D15(F)	
Parameter	Conditions		Min	Max	Min	Max	Min	Max
Output Voltage (V)	I _{O1} =I _{O2} =full load	Ambient temperature high and low temperature	4.950	5.050	11.88	12.12	14.85	15.15
		Ambient temperature high and low temperature	4.850	5.150	11.64	12.96	14.55	15.45
		Ambient temperature high and low temperature	-5.075	-4.925	-12.18	-11.82	-15.23	-14.77
Output Current(A)	V _{IN} = 16 TO 40 VDC		—	2.5	—	1.25	—	1
Output Power (W)	—		—	25	—	30	—	30
Output Ripple Voltage (mV)	BW=10 kHz to 2 MHz I _{O1} = I _{O2} = full load	Ambient temperature high and low temperature	—	40	—	80	—	80
		Ambient temperature high and low temperature	—	90	—	120	—	120
Line Regulation (mV)	V _{IN} = 16 TO 40 VDC, I _{O1} = I _{O2} = full load	+V _{out}	—	50	—	50	—	50
		-V _{out}	—	100	—	150	—	180
Load Regulation (mV)	I _{O1} = I _{O2} =No load to full load	+V _{out}	—	50	—	50	—	50
		-V _{out}	—	100	—	150	—	180
Input Ripple current (mA)	BW=10 kHz to 10 MHz I _{O1} = I _{O2} = full load		—	50	—	50	—	50
Efficiency (%)	I _{O1} = I _{O2} =full load	Ambient temperature high and low temperature	76	—	79	—	80	—
		Ambient temperature high and low temperature	73	—	76	—	77	—
Isolation (M Ω)	Input to output or any pin to case (except case ground pin) at 500 VDC, T _A = 25° C		100	—	100	—	100	—
Inhibit Function	T _A = 25° C , Inhibit voltage, output disabled		yes		yes		yes	
Protection Function	T _A = 25° C		yes		yes		yes	
Start-up Overshoot (mV pk)	V _{in} =0 to 28V, I _{O1} =I _{O2} =full load		-180	180	-120	120	-150	150
Start-up Delay (ms)	V _{in} =0 to 28V, I _{O1} =I _{O2} =full load		—	5	—	5	—	5
Capacitive Load(μ F)	T _A = 25° C, No effect on DC performance		—	500	—	500	—	500
Switching Frequency (kHz)	I _O =full load		400	600	400	600	400	600
Step Load Response Transient (mV pK)	50% load to full load or full load to 50% load		-300	300	-300	300	-400	400

(to be continued) Table 4 Electrical Characteristics

Step Load Response Recovery (μs)	50% load to full load or full load to 50% load,	—	200	—	200	—	200
Step Line Response Transient (mV pK)	$V_{in}=16\sim 40\text{V}$, $I_{o1}=I_{o2}=\text{full load}$ $V_{in}=40\sim 16\text{V}$, $I_{o1}=I_{o2}=\text{full load}$	-400	400	-400	400	-500	500
Step Line Response Recovery (μs)	$V_{in}=16\sim 40\text{V}$, $I_{o1}=I_{o2}=\text{full load}$ $V_{in}=40\sim 16\text{V}$, $I_{o1}=I_{o2}=\text{full load}$	—	300	—	300	—	300
Load Fault Short Circuit recovery (ms)	$I_{o1}=I_{o2}$: short circuit to full load	—	5	—	5	—	5

Notes to Specifications:

- ① The step load transition time should be greater than or equal to $10\mu\text{s}$.
- ② The step line transition time should be greater than or equal to $10\mu\text{s}$.
- ③ Recovery time is measured from application of the transient to point at which V_{OUT} is within 1% of V_{OUT} at final value.

HTR28T512(F), HTR28T515(F)

Table 5 Electrical Characteristics: ($T_{CASE} = -55^{\circ}\text{C}$ to $+125^{\circ}\text{C}$, $V_{IN} = 28\text{V} \pm 0.5\text{V}$, Full Load₅, Unless Otherwise Specified)

Triple output models			HTR28T512(F)		HTR28T515(F)	
Parameter	Conditions		Min	Max	Min	Max
Output Voltage (V)	$I_{o1}=I_{o2}=I_{o3}=\text{full load}$	Ambient temperature high and low temperature	4.95 4.85	5.05 5.15	4.95 4.85	5.05 5.15
		Ambient temperature high and low temperature	11.82 11.58	12.18 12.42	14.77 14.47	15.23 15.52
		Ambient temperature high and low temperature	-12.18 -12.42	-11.82 -11.58	-15.23 -15.52	-14.77 -14.47
Output Current (A)	$V_{IN} = 16 \text{ TO } 40 \text{ VDC}$	+5V _{out}	0.1	4	0.1	4
		+V _{out}	—	0.416	—	0.333
		-V _{out}	—	0.416	—	0.333
Output Power (W)	—		—	30.84	—	30.84
Output Ripple Voltage(mV)	BW=10 kHz to 2 MHz $I_{o1}=I_{o2}=I_{o3}=\text{full load}$	+5V _{out}	—	125	—	125
		+V _{out}	-60	60	-60	60
		-V _{out}	-60	60	-60	60
Line Regulation (mV)	$V_{IN} = 16 \text{ TO } 40 \text{ VDC}$, $I_{o1}=I_{o2}=I_{o3}=\text{full load}$	+5V _{out}	—	20	—	20
		+V _{out}	-75	75	-75	75
		-V _{out}	-75	75	-75	75
Load Regulation (mV)	$I_{o1}=I_{o2}=I_{o3}=\text{No load to full load}$	+5V _{out}	—	50	—	50
		+V _{out}	-75	75	-75	75
		-V _{out}	-75	75	-75	75
Input Ripple current (mA)	BW=10 kHz to 10 MHz $I_{o}=\text{full load}$	Ambient temperature	—	45	—	45
		high and low temperature	—	80	—	80
Efficiency (%)	$I_{o1}=I_{o2}=I_{o3}=\text{full load}$	Ambient temperature	72	—	73	—
		high and low temperature	70	—	71	—

(to be continued)Table 5 Electrical Characteristics

Isolation (M Ω)	Input to output or any pin to case (except pin 6,7) at 500 VDC, T _A = 25° C	100	—	100	—	
Inhibit Function	T _A = 25° C, Inhibit voltage, output disabled	yes		yes		
Protection Function	T _A = 25° C	yes		yes		
Start-up Overshoot (mV pk)	V _{in} =0 to 28V, I _o =full load	+5V _{out}	—	500	—	500
		+V _{out}	—	1500	—	1500
		-V _{out}	—	1500	—	1500
Start-up Delay(ms)	V _{in} =0 to28V, I _o =full load	—	6	—	6	
Capacitive Load(μ F)	T _A = 25° C, No effect on DC performance	—	—	—	—	
Switching Frequency(kHz)	I _o =full load	400	600	400	600	
Step Load Response Transient (mV pK)	50% load to full load or full load to 50% load,	+5V _{out}	-250	250	-250	250
		+V _{out}	-800	800	-800	800
		-V _{out}	-800	800	-800	800
Step Load Response Recovery (mV pK)	50% load to full load or full load to 50% load,	+5V _{out}	—	100	—	100
		+V _{out}	—	4000	—	4000
		-V _{out}	—	4000	—	4000
Step line Response Transient (mV pK)	V _{in} =16~40V, I _o =full load V _{in} =40~16V, I _o =full load	-800	800	-800	800	
Step Line Response Recovery (μ s)	V _{in} =16~40V, I _o =full load V _{in} =40~16V, I _o =full load	—	5000	—	5000	
Load Fault recovery (ms)	I _o :short circuit to full load	—	6	—	6	

Notes to Specifications:

- ① The step load transition time should be greater than or equal to 10 μ s.
- ② The step line transition time should be greater than or equal to 10 μ s.
- ③ Recovery time is measured from application of the transient to point at which V_{OUT} is within 1% of V_{OUT} at final value.

HTR28T515-A , HTR28T515-B

Table 6 Electrical Characteristics: ($T_{CASE} = -55^{\circ}C$ to $+125^{\circ}C$, $V_{IN} = 28V \pm 0.5V$, Full Load⁵, Unless Otherwise Specified)

Parameter	Triple output models		HTR28T515-A		HTR28T515-B	
	Conditions		Min	Max	Min	Max
Output Voltage (V)	$I_{O1} = I_{O2} = I_{O3} = \text{full load}$	Ambient temperature high and low temperature	4.90 4.80	5.10 5.20	4.90 4.80	5.10 5.20
		Ambient temperature high and low temperature	-15.15 -15.40	-14.85 -14.60	-15.15 -15.40	-14.85 -14.60
		Ambient temperature high and low temperature	14.85 14.60	15.15 15.40	14.85 14.60	15.15 15.40
Output Current (A)	$V_{IN} = 16 \text{ TO } 40 \text{ VDC}$	+5V _{out}	3	—	3	—
		+V _{out}	0.5	—	0.5	—
		-V _{out}	0.5	—	0.5	—
Output Power(W)	—		—	30.84	—	30.84
Output Ripple Voltage (mV)	BW=10 kHz to 2 MHz $I_{O1} = I_{O2} = I_{O3} = \text{full load}$	+5V _{out}	—	50	—	80
		+V _{out}	—	100	—	100
		-V _{out}	—	100	—	100
Line Regulation (mV)	$V_{IN} = 16 \text{ TO } 40 \text{ VDC}$, $I_{O1} = I_{O2} = I_{O3} = \text{full load}$	+5V _{out}	—	50	—	50
		+V _{out}	—	80	—	80
		-V _{out}	—	80	—	80
Load Regulation (mV)	$I_{O1} = I_{O2} = I_{O3} = \text{No load to full load}$	+5V _{out}	—	50	—	50
		+V _{out}	—	80	—	100
		-V _{out}	—	80	—	100
Input Ripple current (mA)	BW=10 kHz to 10 MHz $I_{O} = \text{full load}$		—	—	—	—
Efficiency (%)	$I_{O1} = I_{O2} = I_{O3} = \text{full load}$		75	—	75	—
Isolation (M Ω)	Input to output or any pin to case (except pin 6,7) at 500 VDC, $T_A = 25^{\circ}C$		100	—	100	—
Inhibit Function	$T_A = 25^{\circ}C$, Inhibit voltage, output disabled		yes		yes	
Protection Function	$T_A = 25^{\circ}C$		—		—	
Start-up Overshoot (mV pK)	$V_{in} = 0 \text{ to } 28V$, $I_{O} = \text{full load}$	+5V _{out}	—	—	—	—
		+V _{out}	—	—	—	—
		-V _{out}	—	—	—	—
Start-up Delay(ms)	$V_{in} = 0 \text{ to } 28V$, $I_{O} = \text{full load}$		—	—	—	—
Capacitive Load(μF)	$T_A = 25^{\circ}C$, No effect on DC performance		—	—	—	—
Switching Frequency(kHz)	$I_{O} = \text{full load}$		—	—	—	—
Step Load Response Transient (mV pK)	50% load to full load or full load to 50% load,	+5V _{out}	—	—	—	—
		+V _{out}	—	—	—	—
		-V _{out}	—	—	—	—
Step Load Response Recovery (mV pK)	50% load to full load or full load to 50% load,	+5V _{out}	—	—	—	—
		+V _{out}	—	—	—	—
		-V _{out}	—	—	—	—
Step line Response Transient (mV pK)	$V_{in} = 16 \sim 40V$, $I_{O} = \text{full load}$	—	—	—	—	
	$V_{in} = 40 \sim 16V$, $I_{O} = \text{full load}$	—	—	—	—	
Step Line Response Recovery (μs)	$V_{in} = 16 \sim 40V$, $I_{O} = \text{full load}$	—	—	—	—	
	$V_{in} = 40 \sim 16V$, $I_{O} = \text{full load}$	—	—	—	—	
Load Fault recovery (ms)	I_{O} :short circuit to full load		—	—	—	—

Notes to Specifications:

- ① The step load transition time should be greater than or equal to 10 μs .
- ② The step line transition time should be greater than or equal to 10 μs .

⁵ Recovery time is measured from application of the transient to point at which V_{out} is within 1% of V_{out} at final value.

4 TYPICAL PERFORMANCE CURVES of Mil-cots DC DC

converters-HTR28 Series

(1) Single output (Model HTR28S15)

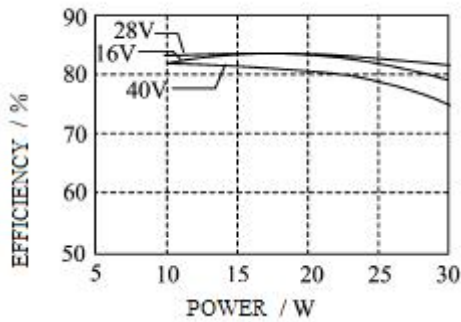

Figure 2 Efficiency (Output Power)

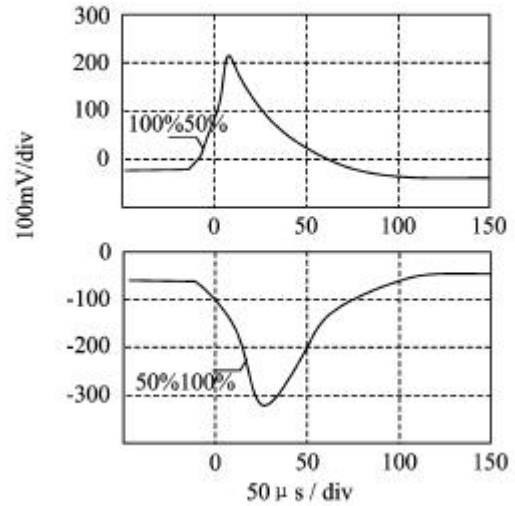

Figure 3 Step Load Response

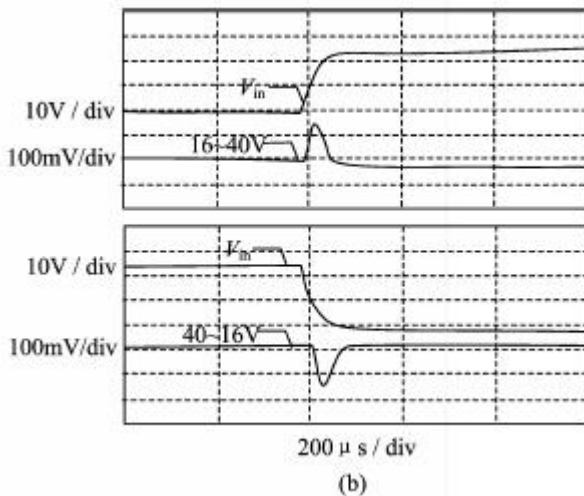

Figure 4 Step Line response

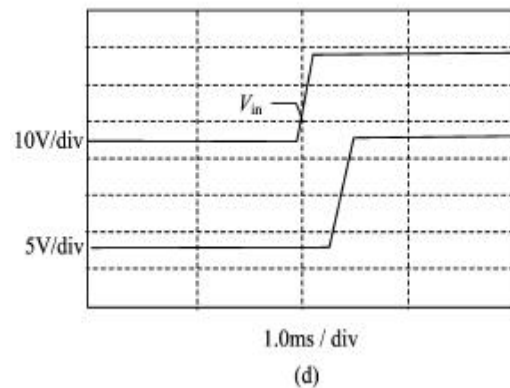

Figure 5 Start-up Overshoot/ Start-up Delay

(2) Dual Output (Model HTR28D15)

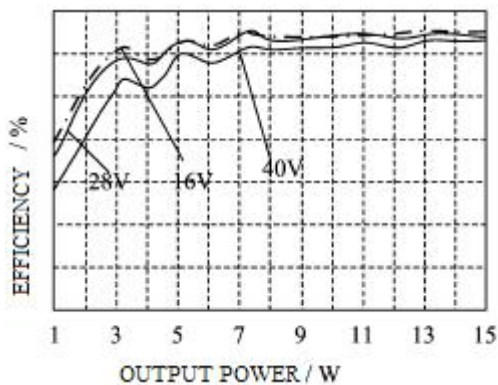

Figure 6 Efficiency (Output Power)

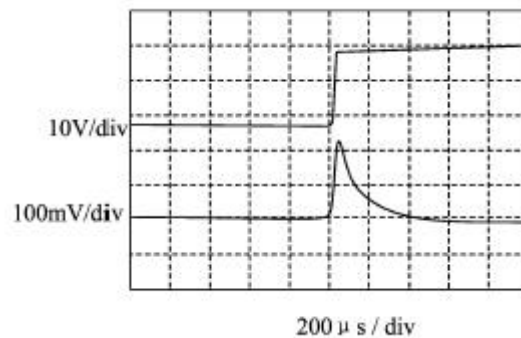

Figure 7 Step Line response

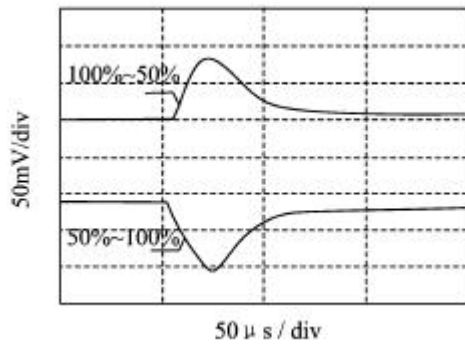

Figure 8 Step Load Response

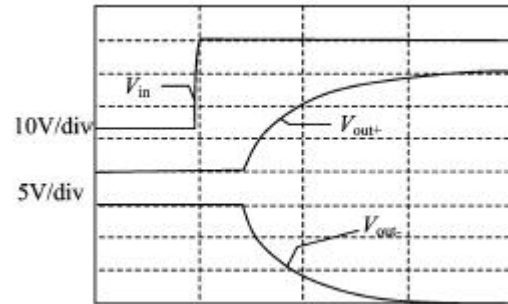

Figure 9 Start-up Overshoot/ Start-up Delay

(3) Triple output (Model HTR28T515)

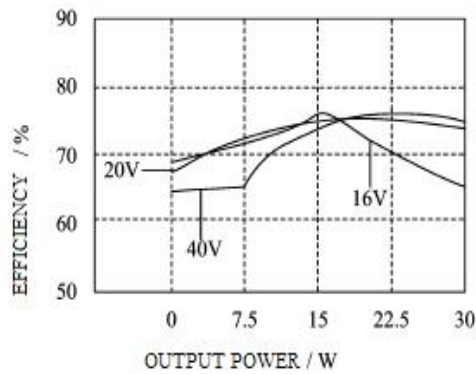

Figure 10 Efficiency (Output Power)

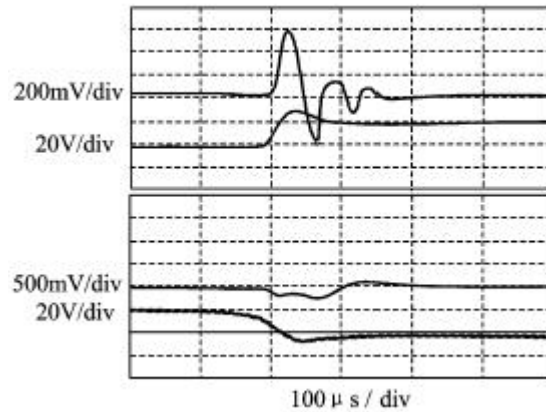
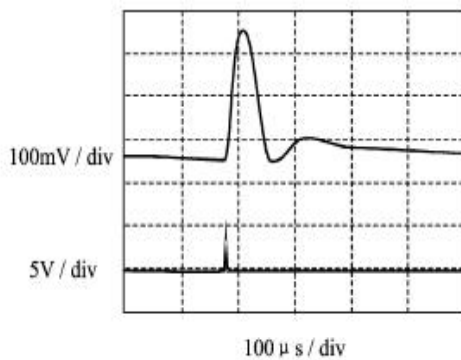
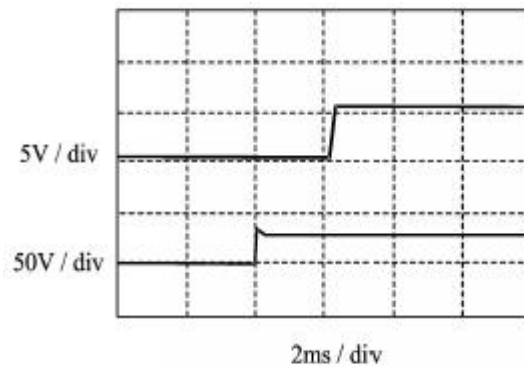

Figure 11 Step Line response



(c)

Figure 12 Step Load Response



(d)

Figure 13 Start-up Overshoot/ Start-up Delay

5 TYPICAL MTBF CURVES of Mil-cots DC DC converters-HTR28 Series

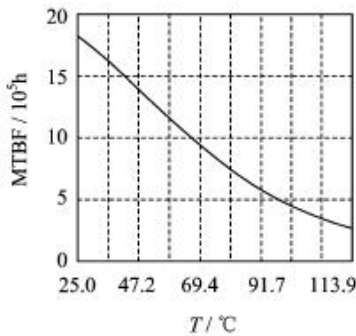

Figure 14 Model HTR28S12

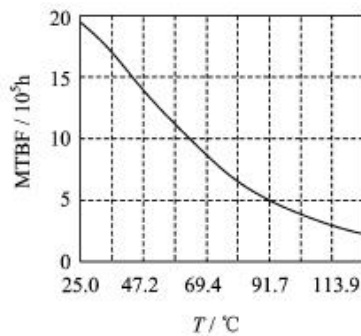

Figure 15 Model HTR28D12

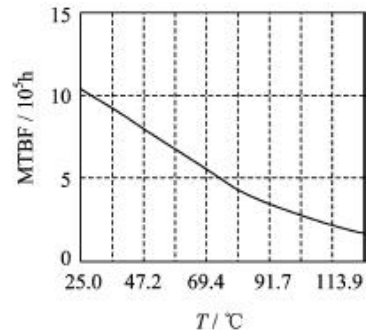

Figure 16 Model HTR28T515-A

6 TYPICAL CONNECTION DIAGRAM of Mil-cots DC DC converters-HTR28 Series

converters-HTR28 Series

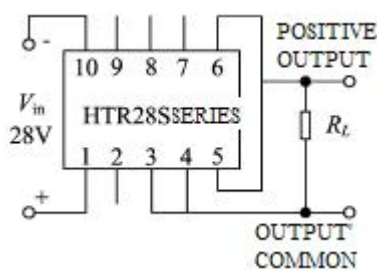

Figure 17 Application Connection Diagram for Single output models

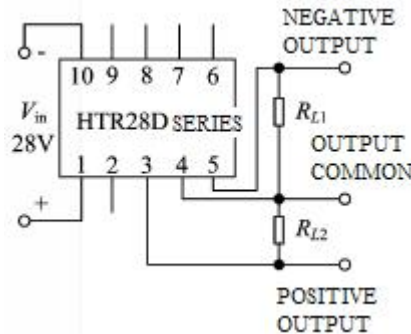

Figure 18 Application Connection Diagram for Dual output models

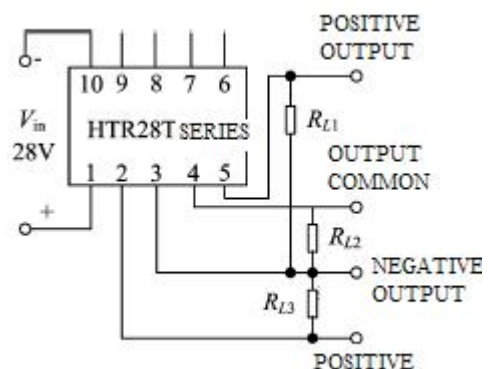

Figure 19 Application Connection Diagram for Triple output models

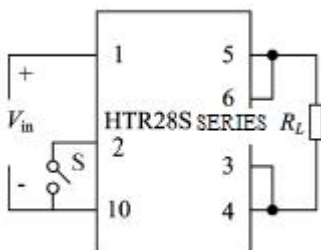

Figure 20 Inhibit Drive connection Diagram for Single Output Models

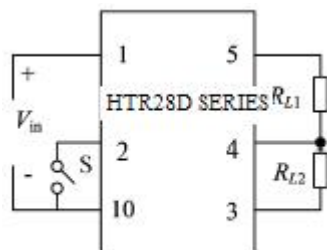

Figure 21 Inhibit Drive connection Diagram for Dual Output Models

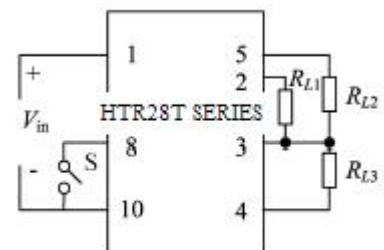

Figure 22 Inhibit Drive connection Diagram for Triple Output Models

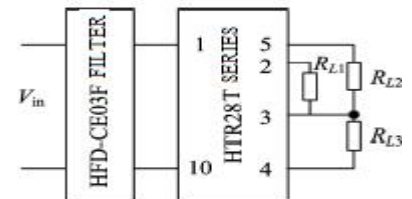
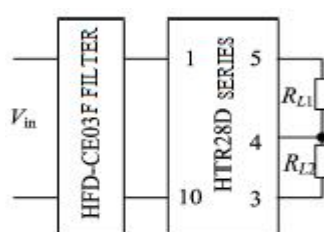
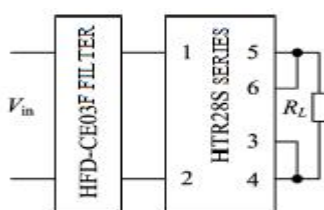

Figure23 Single Output Converter with EMI Filter connection Diagram

Figure24 Dual Output Converter with EMI Filter connection Diagram

Figure25 Triple Output Converter with EMI Filter connection Diagram

7 PACKAGE SPECIFICATIONS of Mil-cots DC DC converters-HTR28 Series

(Units:mm)

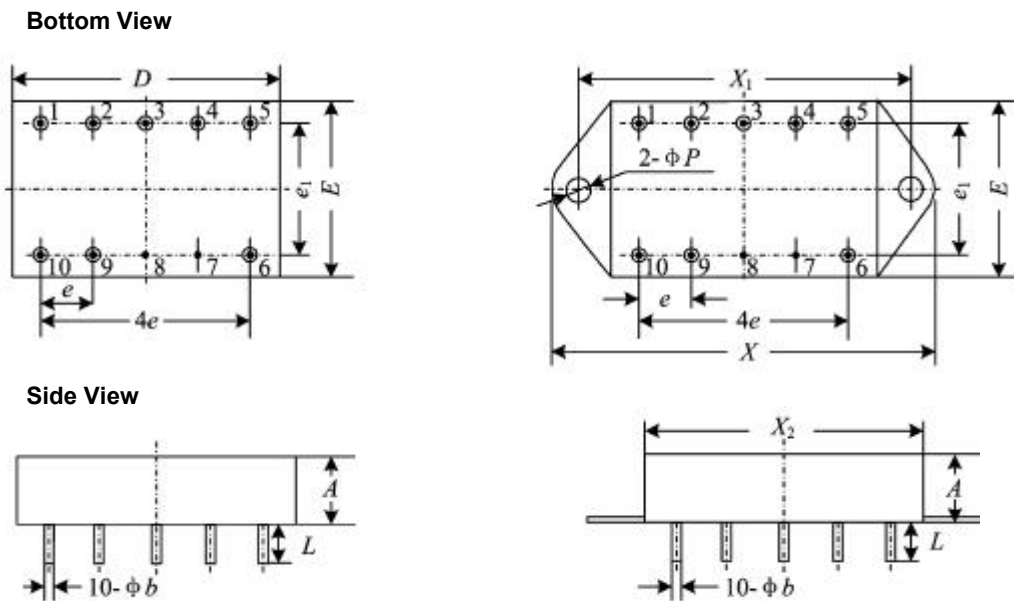

Figure 26 Single Output Model

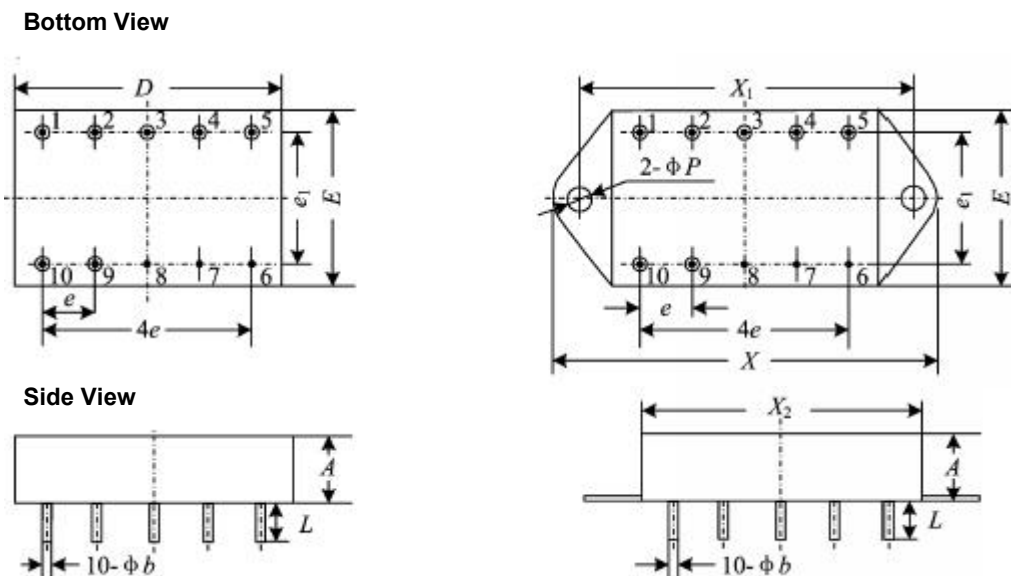
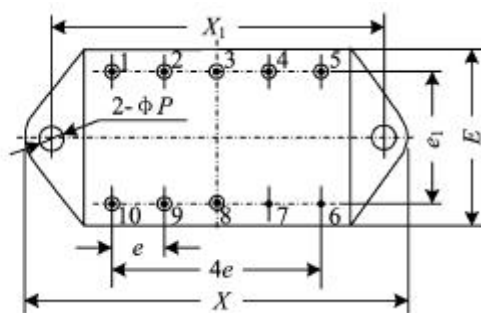
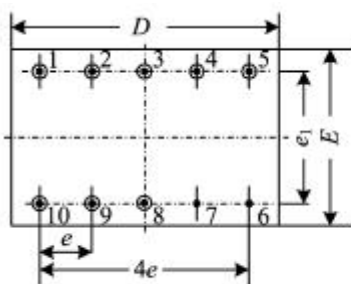

Figure 27 Dual Output Model

Bottom View



Side View

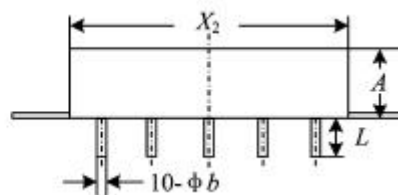
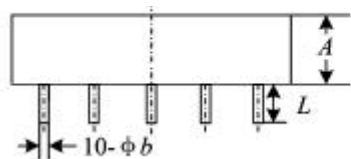

Figure 28 Triple Output Model

Table 7 Package Outline

Units:mm			
Dimension Symbols	Minimum	Nominal	Maximum
A	—	—	10.16
ϕb	0.89	—	1.14
D	—	—	53.98
e	—	10.16	—
e_1	—	20.32	—
E	—	—	28.58
L	6.09	—	6.60
ϕP	3.99	—	4.19
X	—	—	73.91
X_1	64.52	—	65.02
X_2	—	—	53.98

Table 8 Package Outline OF Model HTR28T512(F), Model HTR28T515(F)

Units:mm			
Dimension Symbols	Minimum	Nominal	Maximum
A	—	—	10.29
ϕb	0.89	—	1.14
D	—	—	49.53
e	—	10.16	—
e_1	—	25.40	—
E	—	—	34.29
L	6.10	—	6.60
ϕP	3.99	—	4.19
X	—	—	69.09
X_1	59.70	—	60.20
X_2	—	—	49.58

Table 9 Package Outline OF Model HTR28T515-A, Model HTR28T515-B

Units:mm			
Dimension Symbols	Minimum	Nominal	Maximum
A	—	—	10.90
ϕb	0.80	—	1.20
e	—	10.16	—
e_1	—	25.40	—
E	—	—	34.90
L	5.40	—	—
ϕP	3.70	—	4.70
X	—	—	69.50
X_1	59.64	—	60.24

Table 10 Case Materials

Case Model	Header	Header Plating	Cover	Cover Plating	Pin	Pin Plating	Sealing Style	Notes
UPP5429-10 (Single&Dual)	Cold Rolled Steel(10#)	Nickel	Iron/Nickel Alloy(4J42)	Nickel	Copper Compound	Nickel/Gold	Compression Seal	Nickel plating is for case ground pin.
UPP5034-10c (Triple)	Cold Rolled Steel(10#)	Nickel	Iron/Nickel Alloy(4J42)	Nickel	Iron/Nickel Alloy(4J50)	Nickel/Gold	Compression Seal	Nickel plating is for case ground pin.

Notes:Solder pins individually with heat application not exceeding 300° C for 10 seconds per pin.

8 PIN DESIGNATION of Mil-cots DC DC converters-HTR28 Series

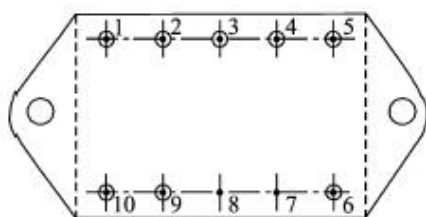

Figure29 Pin Out Bottom View (Single)

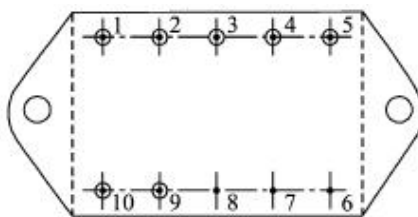

Figure29 Pin Out Bottom View (Dual)

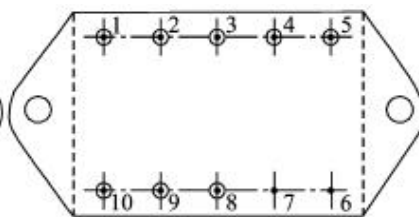

Figure29 Pin Out Bottom View (Triple)

Table 11 Pin designation

Pin	Single Output	Dual Output	Triple Output
1	Positive Input	Positive Input	Positive Input
2	Inhibit	Inhibit	Positive Output (5V)
3	Negative Inductive	Positive Output	Output Common
4	Output Common	Output Common	Negative Output
5	Positive Output	Negative Output	Positive Output
6	Positive Inductive	Case Ground	Case Ground
7	Case Ground	Case Ground	Case Ground
8	Case Ground	Case Ground	Inhibit
9	Synchronous	Synchronous	Synchronous
10	Input Common	Input Common	Input Common

9 ORDERING INFORMATION of Mil-cots DC DC converters-HTR28 Series

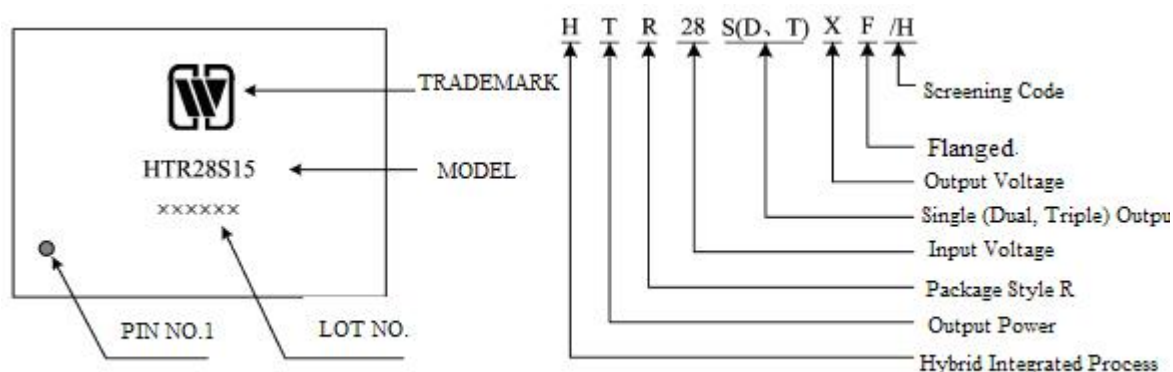

Figure32 Part Numbering Key

Application Notes:

- The correct power supply is to be ensured that may not cause permanent damage to the device.
- When the electrical performance is tested, the testing position should be pin of the device.
- When the device is mounted, the bottom of the device should be closely attached to the circuit board. So as to avoid the damage of the pins, the shockproof should be increased when it is required
- The pin should not be bending to avoid the glass insulator breaking and case leakage.
- When the case temperature is at 105°C, it is suggested that thickness of the thermal sinking plate(copper material) is 3mm, the dimension is greater than 100mm×100mm.
- When the case temperature is at 125°C, it is suggested that thickness of the thermal sinking plate is 3mm, the dimension is greater than 120mm×80mm.

To request a quotation or place orders ,please contact our sales representative or the ECRIM SalesDepartment at:

Sales Phone: (086) 0551-3667943

Sales Fax: (086) 0551-3638101

E-mail: sales@ecrim.cn